

YAMAHA

Power Amplifiers

P1 150
P1 250
P2 150
P2 250

Operating Manual

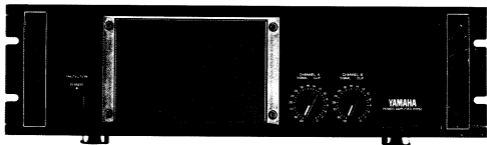

P2250

HOW TO USE THIS MANUAL

If you are an engineer or technician who is familiar with sound system design, much of this manual will serve as a review for you. The basic features are presented in the "BRIEF OPERATING INSTRUCTIONS" section. Check this and the "SPECIFICATIONS" section, and you will see most of what you need to know. The P2250, in bridged MONO mode, will deliver 63 volts to the speaker line and therefore may be used to drive a slightly derated 70 volt line; if you are planning to do this, see the topic titled "Distributed speaker systems and constant voltage lines" in the MORE INFORMATION ON SOUND SYSTEM WIRING section.

If you would like to know more about AC power distribution and safety, grounding, speaker systems, crossovers, and so forth, this information is also presented. Check the Table of Contents.

Since we are covering two single-channel and two dual-channel models, we will sometimes refer to "each channel of the amplifier." Obviously, with the single-channel versions, this refers to the one and only channel. Also, due to common usage and for convenience, we will sometimes refer to the dual-channel models as "stereo" models... especially because they have a rear-panel MONO/STEREO switch. Bear in mind, however, that the two channels may be used for dual monaural programs, for two sections of a bi-amplified speaker system, or for bridged monaural operation — so "stereo" is not necessarily an accurate description of the amplifier in every application.

TABLE OF CONTENTS

INTRODUCTION	2	How crossover networks operate and what they do . . .	27
BRIEF OPERATING INSTRUCTIONS	3	The difference between low and high level crossovers	28
Front Panel	3	The pros and cons of low level and high level crossovers	28
Rear Panel	5	The meaning of various amplifier power rating methods	30
Amplifier Operation	7	PROTECTION FOR SPEAKERS	31
Precautions regarding AC power source for amplifiers . . .	7	Output relay	31
INSTALLATION	8	Current limiting	31
Input Connections	8	Speaker fuses	31
Output Connections	9	Compressor/limiters	32
MORE INFORMATION ON SOUND SYSTEM WIRING	11	Equalizers and filters	32
Balanced and unbalanced wiring	11	High frequency driver protection networks (filters)	32
Why input transformers sometimes are used	12	SPECIFICATIONS	34
Noise and losses in low impedance and high impedance lines	13	P1150	34
Signal levels, dynamic range and headroom	13	P1250	35
Grounding	16	P2150	36
AC outlet wiring affects grounding and safety	19	P2250	37
Speaker Wiring	21	BLOCK DIAGRAM	38
Distributed speaker systems and constant voltage lines . . .	24	PERFORMANCE GRAPHS	39
How to calculate amplifier power output in bridged MONO mode	25	DIMENSIONS	41
MULTI-AMPLIFIED SPEAKER SYSTEMS (Biamping, triamping and so forth)	26		

INTRODUCTION

This manual describes four different, yet similar, power amplifiers. They share similar packaging, features and circuitry. They differ in power output per channel, and in the number of channels.

The P1150 is single-channel amplifier rated at 100 watts into 8 ohms or 150 watts into 4 ohms; the dual-channel P2150 delivers the same power output per channel. The P1250 is a single-channel amplifier rated at 170 watts into 8 ohms or 250 watts into 4 ohms; the dual-channel P2250 delivers the same power output per channel.

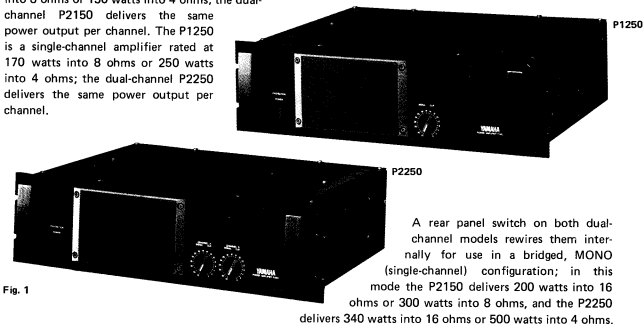

A rear panel switch on both dual-channel models rewires them internally for use in a bridged, MONO (single-channel) configuration; in this mode the P2150 delivers 200 watts into 16 ohms or 300 watts into 8 ohms, and the P2250 delivers 340 watts into 16 ohms or 500 watts into 4 ohms.

These amplifiers are equipped with features that make them well suited to a variety of sound reinforcement, recording and musical instrument applications. Electronically balanced, differential input circuits allow the use of long, shielded 3-wire input cables to reduce susceptibility to hum. Each input appears at an XLR connector and a pair of phone jacks. The XLR inputs combine the advantages of electrostatic and electromagnetic noise rejection, with locking terminals that won't pull out accidentally should the cable be tugged. The phone jacks provide for fast, compatible connection to equipment that utilizes phone jack outputs. By providing two phone jacks instead of one per channel, the amplifiers make it easy to "daisy chain" connect more than one amplifier to a given signal source — no "Y" adapter cable is required.

The output circuitry is fully protected from overloads and short circuits, and the speaker outputs are relay-protected against turn-on transients and DC offset. A two-stage, temperature-operated cooling fan pulls air through a front panel filter to keep the power transformer and heat sinks cool; further protection is afforded by a thermal breaker. Output connections are made via either phone jacks or 5-way binding posts. The binding posts provide more secure wiring, better current-handling capability, and less tendency to build up contact resistance than typical phone jack outputs. Phone jack outputs are provided for convenience in fast setup situations. The amplifiers are rated for 4-ohm or higher impedance loads.

These amplifiers are professional in every detail, right down to the input attenuators — recessed controls with 32 calibrated positions and rubber security caps. Rather than experiment with exotic designs, Yamaha has applied field-proven principles to design amplifiers which are highly stable and which should deliver the kind of reliability for which Yamaha has earned a solid reputation. As with any product, however, proper installation and use is essential to success. This manual has been prepared to assist you in getting the most out of your new Yamaha power amplifier. We encourage you to read it thoroughly.

BRIEF OPERATING INSTRUCTIONS

Front Panel

- P1150/P1250

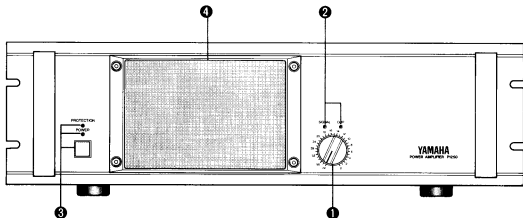

- P2150/P2250

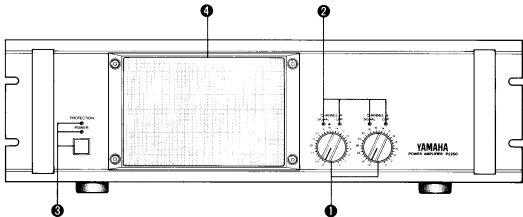

1 INPUT ATTENUATOR(S)

The P1150 and P1250 each have one, and the P2150 and P2250 each have two log-linear input attenuators. Each control is marked in 32 dB-calibrated steps, and detented for extra accuracy. The attenuators provide a smooth, noise-free transition from maximum level (zero attenuation) to silence ("infinite" attenuation). The attenuators are recessed (flush with the front panel) to avoid damage or accidental setting changes.

Calibrated input attenuators offer numerous advantages. They allow predictable and repeatable setups in portable sound systems, as well as in permanently installed systems which are pre-checked in the shop and later installed at another location. Whether the amplifiers are used on stage in portable sound systems or installed in studios, factories, meeting rooms, theatres, arenas or elsewhere, their calibrated attenuators allow easy, accurate input sensitivity adjustments. The calibrated attenuators permit operators to adjust the level of two channels (or two programs on separate amplifiers) with precise tracking.

2 INPUT LEVEL INDICATORS (SIGNAL, CLIP)

A pair of LEDs above the input attenuator monitor the signal level. The green "SIGNAL" LED turns on whenever the signal present at the amplifier output is 2 volts RMS or higher. Since this is equivalent to 1 watt into a 4-ohm load, or 1/2 watt into an 8-ohm load, the SIGNAL LED basically indicates that some program material is present. The red "CLIP" LED turns on when the output stage is about to clip, either from an overdriven input or an overloaded output. This "flags" the operator, suggesting the attenuator be turned down or the speaker load corrected to avoid distortion.

Fig. 2

❶ POWER SWITCH, POWER & PROTECTION INDICATORS

An alternate-action switch turns the AC power on and off. When the power is ON, a red LED immediately above the switch is illuminated. Immediately after turning power on, a second red LED above the PROTECTION label will also be on, indicating the speaker output is disconnected from the load by a protection relay. After a few seconds, the PROTECTION LED should turn off, indicating that the output(s) is activated (the slight delay allows time for the internal amplifier circuits to stabilize and thus avoid turn-on thump). The PROTECTION LED will turn on to indicate that the amplifier output has been disconnected should there be any failure within the amplifier which would otherwise have resulted in DC across the output. Should the VI limiting be triggered by an excess power condition, the power output will be automatically reduced, but this action does not trigger the PROTECTION LED. (The CLIP LED, however, will turn on when the VI limiting is active).

HINT REGARDING TURN-ON OF THE POWER AMPLIFIER

Unless you are turning on all the equipment in the sound system simultaneously with a switched strip of power outlets, be sure to turn on everything else before you turn on the amplifier(s). By turning on the power amplifier last, you can prevent turn-on "thumps" generated by the console, graphic EQ, electronic crossover, or other accessory signal processors from possibly damaging speakers. The opposite procedure should be used to shut off the system: first turn off the amplifier(s), then the rest of the equipment.

These power amplifiers have a relay which is timed to turn on the speaker outputs after the amplifier's power supply is fully charged up, thus preventing any turn-on noise. Timing of the amplifier's turn-on circuit is usually sufficient to accommodate all the turn-on anomalies from other pieces of gear in a system, making it acceptable to use a single switched power strip in a permanently installed or "packaged" portable sound system.

❷ COOLING AIR INTAKE AND FILTER

The amplifier is cooled by a very quiet running, two-speed fan that pulls air through the front-panel grille and exhausts it through vents along the edge of the top and side panels. A reticulated foam element behind the grille filters the air entering the amplifier.

NOTE: The filter element is reusable. When the foam becomes clogged or dirty, it should be cleaned; check it periodically. Using a 3 mm allen wrench, remove the four cap screws that secure the front grille. The foam element may now be removed and rinsed in cool water. For greasy or stubborn dirt, dip the element in a mild solution of detergent and water, then rinse with clear water. Blot and/or air dry the element thoroughly before returning it to the amplifier. **DO NOT USE SOLVENTS TO CLEAN THE FOAM ELEMENT.**

Rear Panel

• P1150/P1250

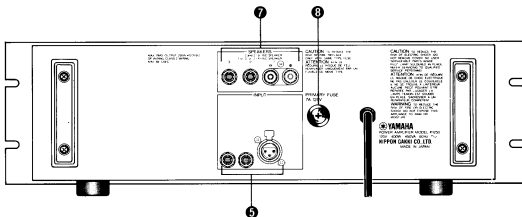

• P2150/P2250

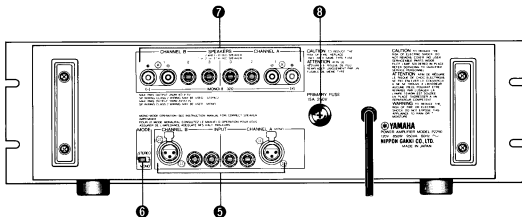

⑥ INPUT CONNECTIONS

Input connectors for each channel include one female XLR connector (electronically balanced) plus a pair of 1/4-inch Tip/Ring/Sleeve phone jacks (for balanced or unbalanced lines). This provides the flexibility necessary for convenient bridging to another amplifier, as well as for economical, secure connection in permanently installed sound systems. Pin 2 of the XLR is wired as the "hot" lead satisfying DIN/JIS and IEEE standards. This corresponds to the tip of the T/R/S phone jacks. Unbalanced T/S phone plugs may be used, as well as balanced T/R/S plugs.

⑥ MODE SWITCH (MONO/STEREO)

This two-position switch selects the operating mode of the P2150 or P2250: STEREO or MONO:

STEREO mode selects independent operation of each amplifier channel. Facing the rear panel, the right-hand pair of (+) and (-) terminals carry signal for the Channel A speaker load, and the left pair of (+) and (-) terminals to the Channel B load.

MONO mode rewires the two channels for bridged mono operation. Only the Channel A input attenuator and input connectors are operative. Connect the speaker load to the two red (+) terminals for Channels A and B; the Channel A (+) terminal has the same polarity as pin 2 of the XLR or the (+) input terminal. Do not allow either of the speaker wires to contact any other wire, chassis, rack or connector.

Fig. 3

④ SPEAKER(S) OUTPUT CONNECTIONS

Each channel's output is brought to three connection points (all wired in parallel): a pair of 5-way binding posts and two 1/4-inch Tip/Sleeve phone jacks. The red (+) and black (-) terminals of the 5-way binding posts are the preferred connections for normal operation. However, many speaker systems are equipped with phone jack inputs, and the amplifier's phone jack outputs provide a convenient means to connect to such speakers with standard phone-to-phone unshielded cables.

While all three output connections may be used simultaneously, make sure the combined load is no less than 4 ohms. See the "Speaker Wiring" subsection of the MORE INFORMATION ON SOUND SYSTEM WIRING" section.

CAUTION

NEVER USE COIL CORDS FOR SPEAKER HOOKUP.

Coiled, and even many non-coiled, guitar-type cords usually have higher internal resistance than the speakers themselves. High resistance is due to the thin wires used to keep the cords flexible (guitar cords are not intended to carry a lot of power, so they don't need thick wires). Such cords prevent most of the power from reaching the speakers, and instead heat up. In high power operation, a guitar-type cord can melt and cause a fire hazard. Use heavy gauge speaker cords with phone plugs if you must use phone plug connections at all; shielded cable is not necessary or desirable for speaker connections.

④ FUSE

Given reasonable ambient temperatures, and free air circulation for the amplifier's cooling system, the output transistors and heat sinks should be able to handle maximum power output indefinitely, but in the event of a power supply problem, or should there be a problem with the power mains themselves, some form of protection is required.

This fuse can be of some value in protecting the power supply against power-line surges and long-term overloads at the outputs. The amplifier is designed to avoid unwanted shutoff during a live performance, but it's better to blow a fuse and replace it than to loose the amp altogether.

NOTE: A thermal breaker is included within the amp, and will shut it down in the event the heat sink temperature reaches 85°C. If there is no output, and the fuse is not blown, the problem may be overheating; wait for the unit to cool, and it should come back on line.

WARNING

ONLY USE FUSES OF THE SAME RATING AND TYPE AS THE ORIGINAL FUSE SPECIFIED FOR THE POWER AMPLIFIER. This information is printed on the amplifier rear panel, and is repeated here for convenience:

FUSE RATINGS:	P1150	5 ampere
	P1250	7 ampere
	P2150	10 ampere
	P2250	15 ampere

Amplifier Operation

This procedure applies to mono systems (with a single-channel amplifier or a stereo amp in bridged mode), as well as to stereo sound systems. It applies to full-range speaker systems which have a passive high-level crossover (or none at all). If you are using the amplifier(s) in a multi-amplified system with an electronic or low-level passive crossover, the Input Attenuator(s) on the amplifier are generally set to maximum (zero loss), and all level controlling is done at the crossover (skip step 10).

1. Make certain all equipment is OFF.
2. Plug the amplifier(s) into a grounded 120 Volt, 50–60 Hz AC power outlet.
3. Connect the wiring from the signal source(s) to the amplifier's input (XLR or phone jack).
4. Select the appropriate setting for the MODE switch (MONO or STEREO) on 2-channel models.
5. Connect the speaker(s) to the output terminals or phone jack(s). On 2-channel models, if used in the MONO mode, DO NOT USE THE PHONE JACKS; connect only to the red (+) terminals of the two channels' 5-way binding posts.
6. Adjust the Input Attenuators to their minimum level (infinite loss) setting.
7. Turn on the entire sound system except the amplifier(s).
8. Adjust the controls on the signal source (typically a console) for "normal" indications on the source's meter or level indicator. If there is no metering, then set the master control at the "nominal" position or mark.
9. Turn the amplifier on. After a short delay, the PROTECTION indicator should turn off (you may hear a "click" from within the amplifier as the output relay engages).
10. Gradually increase the Amplifier Input Attenuator(s) until the CLIP LED just turns on; given a +4 dBu input signal and a typical speaker load, this should occur just as the control(s) reach the maximum (zero loss) setting.* Immediately turn down the Amplifier Input Attenuator(s) by the number of dB (per their calibrated scale) that match the amount of headroom you wish to preserve in the sound system. For a high quality music reproduction system, 20 dB of gain reduction (headroom) is about the most normally used. For a live "rock" music performance, 10 to 15 dB of gain reduction provides for a higher average level while retaining adequate headroom. For paging, or other voice-only or background music systems, 5 to 10 dB of gain reduction (headroom) should be sufficient.

* If the CLIP LED does not come on with the amplifier control(s) at maximum (zero loss), then the source device nominal level is simply lower than -4 dBu. This is not a problem, but in order to establish the desired headroom figure, you will temporarily have to increase the source's output level. Turn it up until the Amplifier's CLIP LED just comes on, and note how much extra level you had to extract from the source. Now bring the source back to its nominal level. Take the number of dB of headroom you wish to establish for the system, subtract the "added level" you just had to extract from the source from this total figure, and turn down the Amplifier Input Attenuator(s) by the resulting figure.

Precautions regarding AC power source for amplifiers

High power amplifiers can draw a lot of AC power. Be sure the AC power source for your AC distribution system has adequate current capability to bear the entire load with an extra margin of safety. If you use a power outlet strip with a built-in fuse or circuit breaker, make sure the breaker is rated for sufficient current to handle the combined load of all equipment plugged into the strip.

In multiple amplifier installations, we recommend sequential turn-on (either manually or via timed relays) to avoid a sudden, major drain on the AC line.

You should also keep in mind that severe reduction of power line voltage affects the amount of power you can get FROM the amplifier. If you need to run long AC extension cords, make sure their conductors are as large as practical (small gauge number). Just as smaller diameter wire causes speaker line loss, smaller power lines cause loss. However, the effect of small AC lines is one of intermittent clipping under severe low-voltage conditions.

WARNING

DO NOT CHANGE A THE FUSE OR CIRCUIT BREAKER IN THE AC POWER DISTRIBUTION SYSTEM TO A HIGHER VALUE UNLESS YOU ARE ABSOLUTELY CERTAIN THE WIRING IS RATED FOR THE HIGHER CURRENT. If a high-current short occurs, the wiring becomes the "fuse," which usually starts a fire before the wiring can "blow". We recommend that you refer to the National Electrical Code before attempting any such change.

INSTALLATION

Input Connections

XLR CONNECTORS AND PHONE JACKS

The amplifier input circuit is electronically balanced. Each channel is equipped with pair of T/R/S phone jacks wired with the tip for signal high (+), the ring for signal low (-) and the sleeve for chassis ground. These jacks are wired in parallel with each other and with an XLR connector in which pin 2 is the "hot" or signal high (+) terminal, pin 3 is signal low (-), and pin 1 is ground. This XLR wiring conforms to the JIS/DIN/IEEC international standards.

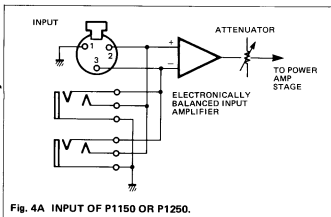

Fig. 4A INPUT OF P1150 OR P1250.

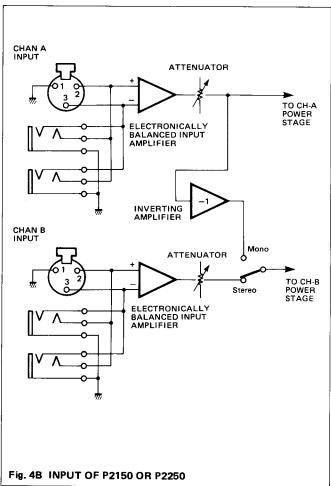

Fig. 4B INPUT OF P2150 OR P2250

As of this date, there is no clear standard in the United States for the polarity of connections on the XLR connector. If opposite amplifier polarity is required, or if the equipment driving the amplifier uses pin 3 as its "hot" lead, the input cable wiring should be reversed from this convention. If using an XLR-fitted cable, rewire it or, preferably, use a polarity-reversal adaptor.

Both the XLR and phone jack inputs may be used at the same time for the purpose of "daisy chaining" the signal to another input; the dual input connections should not be used to "mix" two signal sources to feed a given amplifier channel.

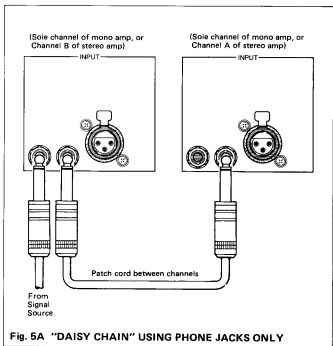

Fig. 5A "DAISY CHAIN" USING PHONE JACKS ONLY

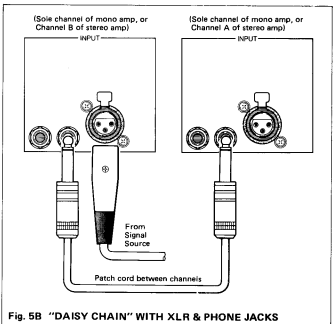

Fig. 5B "DAISY CHAIN" WITH XLR & PHONE JACKS

Output Connections

The amplifier output is brought to both a pair of 1/4-inch T/S phone jacks and to 5-way binding posts marked "SPEAKER" (or "SPEAKERS"). With regard to the binding posts, each amplifier channel has one red (+) and one black (-) terminal for connection to the speaker load. In normal operation, the (+) SPEAKER terminal has the same signal polarity as the tip of the input phone jack or pin 2 of the XLR input (see "MONO MODE CONNECTIONS" for an exception.)

Refer to the discussion of "Speaker Wiring" in the MORE INFORMATION ON SOUND SYSTEM WIRING section of this manual for additional information on calculating load impedances, power loss in cables, and minimum wire gauge recommendations.

NORMAL CONNECTIONS

The following connection diagrams apply to the P1150, P1250, and to discrete 2-channel operation in the P2150 or P2250. Connect the speaker load as illustrated. The minimum nominal load impedance in this mode is 4 ohms.

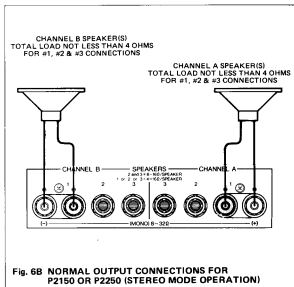

Fig. 6B NORMAL OUTPUT CONNECTIONS FOR P2150 OR P2250 (STEREO MODE OPERATION)

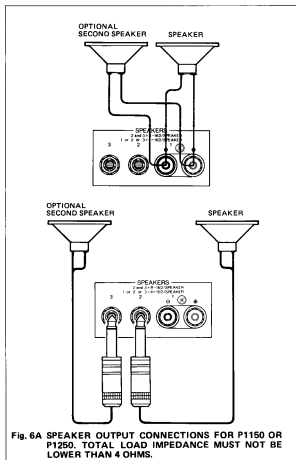
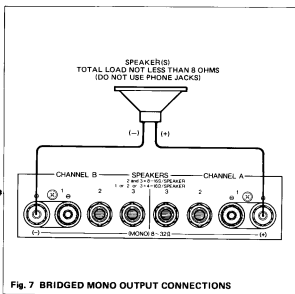

Fig. 6A SPEAKER OUTPUT CONNECTIONS FOR P1150 OR P1250. TOTAL LOAD IMPEDANCE MUST NOT BE LOWER THAN 4 OHMS.

MONO MODE CONNECTIONS

The following connection diagram applies to P2150 or P2250 when operated in bridged MONO configuration.



The rear panel MODE switch, when set to MONO, prepares the amplifier for bridged operation. In this context, "bridged" describes the special wiring of the two channels of the amplifier so that the outputs add together and produce twice the voltage of one channel alone. Since power is proportional to the square of the voltage, bridging can develop up to four times the output power given the same load impedance... assuming that the amplifier can handle it. Typically, however, the maximum available output power in bridged mode is somewhat less than the theoretical 4X increase due to power supply restrictions. Since amplifiers generally cannot handle four times their maximum unbridged (normal STEREO mode) power output when in bridged (MONO) mode, a more useable rule of thumb is that an amp will deliver twice its "normal" rated power into twice its "normal" rated minimum impedance when bridged.

By using both channels of a dual-channel to drive a single speaker load in the bridged (MONO) configuration, it is possible to achieve the wide headroom and dynamic range needed for accurate reproduction of peaks and transient sounds. When a stereo program must be reproduced, then a pair of bridged power amps can be used, each in bridged MONO mode.

One input (Channel A) is all that's required to drive the amplifier when it is operated in MONO mode. The rear panel MONO/STEREO switch "rewires" the input circuits so Channel A feeds both channels of the amplifier simultaneously, and the Channel B output is electronically reversed in polarity with respect to the Channel A output. The Channel B SPEAKER output red (+) terminal then serves as the "low" (-) side of the bridged output, and the channel A SPEAKER output red (+) terminal is the "high" side of the bridged output. Neither black (-) SPEAKER output terminal is used in bridged mode, nor are the 1/4-inch phone jack outputs.

For MONO operation, connect the signal source to the Channel A input; the channel B input should remain unused. Connect the speaker load as illustrated. When the amplifier is set to MONO mode, only the Channel A input connectors and controls are operative, and it's a good idea to turn down the Channel B Input Attenuator to avoid confusion.

CAUTION

NEVER CONNECT THE BLACK (-) SPEAKER OUTPUT TERMINALS TO ANYTHING WHEN THE AMPLIFIER IS IN BRIDGED MONO MODE. In this mode, both of the red (+) SPEAKER output connectors are "hot". Do not allow them to short together, or to any other connections in your sound system.

WARNING

When operating in the bridged mode, the extra voltage warrants extra care to avoid touching speaker wiring since the amplifier can easily deliver a lethal combination of voltage and current.

Make sure that no return path between speaker wiring and equipment chassis or rack cabinets, which are probably grounded, exists any time, especially when you're using the amplifier in the bridged mode of operation. In bridged mode, the red (+) output terminals of the amplifier are both "hot", and are not referenced to ground but only to each other. Thus a return path connected to ground would short one or both sides of the amplifier, could cause the amplifier to shut down, and might even damage it.

In mono mode, never use the 1/4-inch phone jacks on the amplifier, and avoid the use of 1/4-inch phone plugs at the speaker end of the cable. Phone plugs are a poor choice in general for speaker connectors, especially in a bridged system, because these plugs cause a momentary short circuit as they are plugged in or pulled out.

MORE INFORMATION ON SOUND SYSTEM WIRING

The signal-carrying cables in a sound system are as much an audio "component" as any other part of the system. Improper cables between the signal source and the amplifier can result in exaggerated or deficient high frequency response, degradation of signal-to-noise ratio, and other problems. Improper amplifier-to-speaker wiring can degrade amplifier damping factor, reduce power delivered to the speakers, and prematurely trigger protection circuitry. This section of the manual discusses the nature of balanced and unbalanced signal cables, input transformers, signal levels, grounding techniques, and other aspects of system wiring. It is not an all-inclusive handbook, although it should provide a useful background so that problems can be understood and either avoided in the first place or more easily corrected should they occur.

Balanced and unbalanced wiring

In a general sense, there are two types of signal transmission systems for low to medium level audio signals: the balanced line, and the unbalanced line. Either type can be used with high or low impedance circuits; the impedance of a line bears no necessary relationship to its being balanced or not.

The UNBALANCED LINE is simply a "two-wire" system where the shield (ground) acts as one signal-carrying wire, and the center (hot) wire enclosed within that shield is the other signal-carrying wire. The shield is typically a shell made of fine, braided wires, although some cables have "served" (wrapped) shields instead.

The BALANCED LINE is a three-wire system where two signal wires carry an equal amount of potential or voltage WITH RESPECT TO the shield (ground) wire, but of opposite electrical polarity from each other. The shield (ground) in a balanced line does not carry any audio signal, and is intended strictly as a "drain" for spurious noise current that may be induced in the cable from external sources.

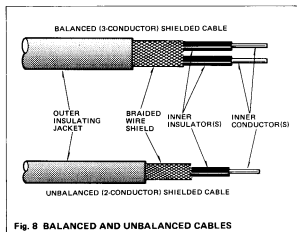

Fig. 8 BALANCED AND UNBALANCED CABLES

Balanced wiring is more expensive and complex than unbalanced wiring. It is often used, however, because it offers important advantages. There is nothing inherently "better" or more "professional" about balanced wiring; the application dictates whether one system or the other is needed to yield satisfactory results.

In electronics laboratories, where critical measurements are made using high-precision test equipment, unbalanced wiring is often used. Unbalanced wiring works best when: high-quality wire is used, the cable extends over relatively short distances, and one leg of the AC power system feeds all the gear. Radio transmitter feeds, computer high-speed data transmission, and ultra-wideband television signals are usually fed over unbalanced lines. In short, there is nothing inherently "unprofessional" about unbalanced wiring.

In electrically "noisy" environments, balanced wiring helps eliminate noise in an ingenious way; the two wires of the "balanced" cable carry the same signal, but each wire is opposite in signal polarity to the other. Balanced inputs are designed to recognize only the DIFFERENCE in voltage between the two wires (hence the term "balanced differential input"). Should any electrostatic interference or noise cut across a balanced cable, the noise voltage will appear equally — with the same polarity — on both signal-carrying wires. The noise is therefore ignored or "rejected" by the input circuit. (This is why the term "common mode rejection" applies; signals in common to the two center wires are rejected.)

Not all balanced wiring has a shield. In older telephone systems, many miles of cable were run with no shielding (that much shielding is too expensive). Out in the open, wires are subjected to radio interference and hum fields set up by power lines. Balancing the two signal hot wires with respect to ground gives long lines immunity to external interference. Using just two simple wires twisted together makes the two signal wires subject to exactly the same amount of bombardment from hum and radio sources, so a balanced input (either transformer or active, differential amplifier) can be used to cancel out unwanted signals on the line while passing the desired audio signal. Figure 9 illustrates the principle of balanced-line interference rejection.

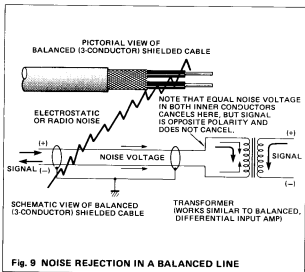

Fig. 9 NOISE REJECTION IN A BALANCED LINE

The RFI (radio frequency interference) cuts across both conductors, inducing equal voltages in the same direction. These voltages "meet" in the transformer (or differential amplifier), and cancel out, while the signals generated by the microphone flow in opposite directions in each conductor, and hence do not cancel out. Thus, in a theoretically perfect balanced system, only the desired signal gets through the transformer or differential amplifier.

Why input transformers sometimes are used

There are a number of reasons why input transformers might be used. We'll discuss just a few of them. In the case of certain audio equipment which has an unbalanced input (not these amplifiers), a transformer converts the unbalanced input to a balanced input. When the transformer is used in this way, primarily for ground isolation and to obtain the benefits of a balanced line, it is said to be an "isolation" transformer or a "matching" transformer. If the transformer is also used to prevent a low impedance input from overloading a high impedance output, it is known as a "bridging" transformer (not to be confused with the "bridged" connections of a stereo power amp output in MONO mode).

Since they already have balanced inputs, these amplifiers have no need for input transformers. There are instances where absolute isolation of the grounds between the power amp and the other equipment must be obtained, and in such cases, there is no viable substitute for a transformer; in such cases, the commercial versions of these amplifiers ("C" suffix) may be used since they include sockets for optional transformers. Alternately, an external input transformer may be used, such as one of the in-line types that fit in a case not much larger than an XLR connector.

NOTE: There are other ways to achieve isolation. One can digitize the audio signal and transmit it by means of modulated light in fiberoptics, but this is much more expensive than using a transformer, with no great performance advantage. One can use the audio signal to modulate a light, and pick up the light with an LDR (light dependent resistor), thus achieving isolation at the expense of increased noise and distortion.

There are also instances where there is an extremely large amount of radiated noise energy near the input cables to the amplifier — for example near an SCR-operated lighting dimmer panel. In such cases, the common mode rejection of the balanced differential amplifier input may not be adequate to cancel out the very high peak noise voltages, and only a good quality input transformer can do the job. In most of the applications for which these amplifiers are intended, you don't need a transformer, and you're not paying for it.

Noise and losses in low impedance and high impedance lines

The length and type of cable can affect system frequency response and susceptibility to noise. The impedance of the line has a major influence here, too.

Signal cables from high impedance sources (actual output impedance of 5000 ohms and up), should not be any longer than 25 feet, even if low capacitance cable is used. The higher the source impedance, the shorter the maximum recommended cable length.

For low impedance sources (output impedances of 600 ohms or less), cable lengths of 100 feet or more are acceptable. For very low impedance sources of 50-ohms or less, cable lengths of up to 1000 feet are possible with minimal loss.

In all cases, the frequency response of the source, the desired frequency response of the system, and the amount of capacitance and resistance in the cable together affect actual high frequency losses. Thus, these suggested cable lengths should not be considered "absolute" rules.

Susceptibility to noise is another factor which affects cable length. All other factors being equal (which they seldom are), if a given noise voltage is induced in both a high impedance and a low impedance cable, the noise will have a greater impact on the high impedance circuit. Consider that the noise energy getting into the cable is more-or-less constant in both instances. The low impedance input is being driven primarily by power, whereas the high impedance input is being driven primarily by voltage. The induced noise energy must do MORE WORK when it drives a lower impedance — it does not have much power — so less noise is amplified by the input circuit. The induced noise energy is not loaded by a high impedance input, and so it is amplified.

Signal levels, dynamic range and headroom

STANDARD OPERATING LEVELS

There are a number of different "standard" operating levels in audio circuitry. It is often awkward to refer to a specific level (i.e., +4 dBu) when one merely wishes to describe a general sensitivity range. For this reason, most audio engineers think of operating levels in three general categories:

1. MIC LEVEL OR LOW LEVEL

This range extends from no signal up to about -20 dBu (77.5 mV), or -20 dBm (77.5 mV across 600 ohms = 10 millionths of a watt). It includes the outputs of microphones, guitar pickups, phono cartridges, and tape heads, prior to any form of amplification (i.e., before any mic, phono, or tape preamps). While some mics can put out

more level in the presence of very low sound, and a hard-picked guitar can go 20 dB above this level (to 0 dBu or higher), this remains the normal, average range.

2. LINE LEVEL OR MEDIUM LEVEL

This range extends from -20 dBu or -20 dBm to +30 dBu (24.5 V) or +30 dBm (24.5V across 600 ohms = 1 watt). It includes preamp and console outputs, and most of the inputs and outputs of typical signal processing equipment such as limiters, compressors, time delays, reverbs, tape decks, and equalizers. In other words, it covers the output levels of nearly all equipment except power amplifiers.

3. SPEAKER LEVEL AND HIGH LEVEL

This covers all levels at or above +30 dBu (24.5V) +30 dBm (24.5 V across 600 ohms = 1 watt). These levels include power amplifier speaker outputs, AC power lines, and DC control cables carrying more than 24 volts.

Let's discuss these levels in the context of a sound system. The lowest power levels in a typical sound system are present at the output of microphones or phono cartridges. Normal speech at about one meter from the "average" dynamic microphone produces a power output from the microphone of about one trillionth of a watt. Phono cartridges playing an average program selection produce as much as a thousand times this output — averaging a few billionths of a watt. These signals are very weak, and engineers know that they cannot be "run around" a chassis or down a long cable without extreme susceptibility to noise and frequency response errors. This is why microphone and phono preamps are used to boost these very low signal levels to an intermediate range called "line level". Line levels are between 10 millionths of a watt and 250 thousandths of a watt (1/4 watt). These levels are related to the "dBm" unit of measurement as follows:

-20 dBm	=	10	microwatts (0.00001 watts)
0 dBm	=	1	milliwatt (0.001 watts)
+4 dBm	=	2.5	milliwatts (0.0025 watts)
+24 dBm	=	250	milliwatts (0.025 watts)

While some console and preamp outputs can drive lower impedances, primarily for driving headphones, typical line levels (measured in milliwatts) cannot drive speakers to useable levels. Not only is the power insufficient for more than "whisper" levels, the console circuits are designed to operate into loads of 600 ohms to 50,000 ohms; they cannot deliver even their few milliwatts of rated power to a typical 8-ohm speaker without being overloaded. A power amplifier must be used to boost the power output of the console so it is capable of driving low impedance speaker loads and delivering the required tens or hundreds of watts of power.

UNDERSTANDING DYNAMIC RANGE AND HEADROOM

Every sound system has an inherent noise floor, which is the residual electronic noise in the system equipment (and/or the acoustic noise in the local environment). The DYNAMIC RANGE of a system is equal to the difference between the peak output level of the system and the noise floor.

A concert with sound levels ranging from 30 dB SPL (near silence) to 120 dB SPL (threshold of pain) has a 90 dB dynamic range. The electrical signal level in the sound system (given in dBu) is proportional to the original sound pressure level (in dB SPL) at the microphone. Thus, when the program sound levels reach 120 dB SPL, the maximum line levels (at the console's output) may reach +24 dBu (12.3 volts), and maximum power output levels from the amplifier may peak at 250 watts. Similarly, when the sound level falls to 30 dB SPL, the minimum line level falls to -66 dBu (0.388 millivolts) and power amplifier output level falls to 250 nanowatts (250 billionths of a watt).

The program, now converted to electrical rather than acoustic signals, still has a dynamic range of 90 dB: +24 dBu - (-66 dBu) = 90 dB. This dB SPL to dBu or dBm correspondence is maintained throughout the sound system, from the original source at the microphone, through the electrical portion of the sound system, to the speaker system output. A similar relationship exists for any type of sound reinforcement, recording studio, disco or broadcast system.

The average line level in the typical commercial sound system just described is +4 dBu (1.23 volts), corresponding to an average sound level of 100 dB SPL. This average level is usually called the "nominal" program level. The difference between the nominal and the highest (peak) levels in a program is the HEADROOM. In the above example, the headroom is 20 dB. Why is this so? Subtract the nominal from the maximum and see: 120 dB SPL - 100 dB SPL = 20 dB. The headroom is always expressed in just plain "dB" since it merely describes a ratio, not an absolute level; "20 dB" is the headroom, not "20 dB SPL". Similarly, the electrical headroom is 20 dB, as calculated here: +24 dBu - (+4 dBu) = 20 dB. Again, "20 dB" is the headroom, not "20 dBu". Provided the amplifier is operated just below its clipping level at maximum peaks of 250 watts, and at nominal levels of 2.5 watts, then it also operates with 20 dB of headroom (20 dB above nominal = 100 times the power).

If another sound system were equipped with a noisier circuit somewhere along the line, and a less capable line amplifier than the previous example, it might have an electronic noise floor of -56 dBu (1.23 millivolts), and a peak output level of +18 dBu (6.16 volts). The dynamic range of this system would only be 74 dB. Assuming the original program still has an acoustic dynamic range of 90 dB, it is apparent that 16 dB of the program will be "lost" in the sound system. How is it

lost? There may be extreme clipping of program peaks, where the output does not rise higher in response to higher input levels. Quiet passages, corresponding to the lowest signal levels, may be buried in the noise. Typically, portions of that 16 dB difference in dynamic range between the sound system capability and the sound field at the microphone will be lost in both ways. A system with +24 dBu output capability and a -66 dBu or better noise floor, would be able to handle the full 90 dB dynamic range. Thus, for high quality sound reinforcement or music reproduction, it is necessary that the sound system be capable of low noise levels and high output capability.

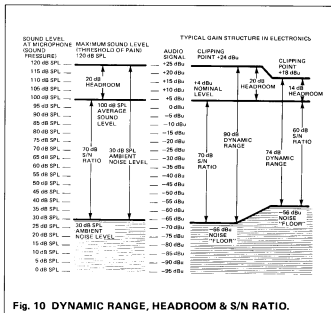

In the special case of an analog audio tape recorder, where the dynamic range often is limited by the noise floor and distortion levels of the tape oxide rather than the electronics, there is a common method used to avoid program losses due to clipping and noise. Many professional and consumer tape machines are equipped with a noise reduction system, also known as a compander (as designed by firms like Dolby Laboratories and dbx, Inc.). A compander noise reduction system allows the original program dynamics to be maintained throughout the recording and playback process by compressing the program dynamic range before it goes onto the tape, and complementarily expanding the dynamic range as the program is retrieved from the tape. Compact (laser) discs, and digital audio tape recording, and the FM recording used in modern stereo VCR soundtracks are additional methods of recording wide dynamic range programs which, in turn, demand playback systems with wide dynamic range.

A GENERAL APPROACH TO SETTING LEVELS IN A SOUND SYSTEM

Volume control and fader settings throughout a sound system affect the noise and headroom of the system. To provide the best overall system performance, level settings should be optimized for each component in the system. One popular approach is to begin by adjusting levels as close as possible to the signal source (i.e., at the console input or microphone preamp). Set the input pad and/or gain trim controls for the maximum level that will not produce clipping (overdrive); this can be seen if the console has Peak input level LEDs, or heard by listening for distortion while making adjustments. The next step is to set the level of the console input channel (the fader or send control) so that it properly drives the mixing busses. Consoles with VU meters should indicate bus levels, although you'll want to check the block diagram; sometimes it is possible to overdrive a bus summing amplifier and still have the bus output VU meter indicate "normal" levels.

If line amplifiers, electronic crossovers, equalizers or other signal processing devices are inserted in the signal chain, signal levels at the input of these units should be set so the dynamic range of each unit is optimized. In other words, set the input level at each device as high as possible without producing clipping, and, if an output level control is provided, also set it as high as possible without clipping the output — and without causing clipping in the input of the next device to which it is connected.

Check the operating manual of each piece of equipment to determine the specified nominal and maximum input levels. An accurate AC voltmeter is often helpful for verifying levels. As a rule, keep signal levels as high as possible throughout the system, up to the input of the power amplifier(s). Then reduce the program level, as required, using the amplifier's input attenuators. Input attenuators should be set so that maximum program levels from the source equipment won't drive the amplifiers to clipping. This keeps overall system noise as low as possible.

HOW TO SELECT A HEADROOM VALUE AND ADJUST LEVELS ACCORDINGLY

Recall that headroom is the amount of level available above the average (nominal) signal for peaks in the program.

The choice of a headroom figure depends on the type of program material, the application, and the available budget for amplifiers. For a musical application where high fidelity is the ultimate consideration, 15 to 20 dB of headroom is desirable. For most sound reinforcement applications, especially with large numbers of amplifiers, economics play an important role, and a 10 dB headroom figure is usually adequate; in these applications, a limiter can help hold program peaks within the chosen headroom value, and thus avoid clipping problems. For the extreme situation (as in a factory) where background music and paging must be heard over high continuous noise levels, yet maximum levels must be restricted to avoid dangerously high sound pressure levels, a headroom figure of as low as 5 or 6 dB is not unusual. To achieve such a low headroom figure, an extreme amount of compression and limiting will be necessary, causing the sound to be somewhat unnatural, but the message will "cut through".

Let's go through an actual setup procedure for a high quality, music reproduction system. First choose a headroom figure. For maximum fidelity when reproducing music, it is desirable to allow 20 dB of headroom above the average system output. While some extreme musical peaks exceed 20 dB, the 20 dB figure is adequate for most programs, and allowing for greater headroom can be very costly. A 20 dB headroom figure represents a peak level that is one hundred times as powerful as the average program level. This means that for a 20 dB headroom figure, even an amplifier as powerful as 500 watts has to operate at an average 5 watts output power. In some systems such as studio monitoring, where fidelity and full dynamic range are of utmost importance, this low average power may be adequate. In other situations, such as 70-volt background music systems, a 20 dB headroom figure is not necessary and too costly due to the number of amplifiers required.

After choosing a headroom figure, adjust the incoming and outgoing signal levels at the various devices in the system to achieve that figure. For a typical system, the adjustments for a 20 dB headroom figure would be made as follows:

1. Initially, set the attenuators on the power amp at maximum attenuation (maximum counterclockwise rotation). Feed a sine wave signal at 1000 Hz to the console input at an expected average input level (approximately -50 dBu (2.45 mV) for a microphone, +4 dBu (1.23 volts) for a line level signal. The exact voltage is not critical, and 1000 Hz is a standard reference frequency, but any frequency from 400 Hz to about 4 kHz may be used.

2. Set the input channel level control on the console at its marked "nominal" setting, and adjust the master level control so that the output level is 20 dB below the rated maximum output level for the console. Suppose, for example, the maximum rated output level is +24 dBu (12.3 volts); in that case, the output level should be adjusted to +4 dBu (1.23 volts), as indicated either on an external voltmeter, or on the console's VU meter (typically, 0 VU corresponds to +4 dBu output).
3. Assume that the rated maximum input level for the graphic equalizer to which the console output is connected is +14 dBu (3.88 volts). Subtracting +4 dB from +14 dB leaves only 10 dB of headroom, so a 10 dB resistive pad should be inserted between the console output and the equalizer input. The signal level at the input to the equalizer should now be -6 dBu (388 mV), which can be confirmed with a voltmeter.
4. Assume that the maximum rated output level of the equalizer in this example is +18 dBu (6.16 volts). Adjust the master level control on the equalizer so that its output level is 20 dB below the rated maximum, or -2 dBu (616 mV). Since the equalizer probably has no VU meter, use an external voltmeter to confirm this level.
5. Finally, starting with the attenuator(s) on the amplifier at maximum attenuation (maximum counterclockwise rotation), slowly rotate it clockwise, observing the amplifier's output level. When the POWER output is 1/100 of the maximum rated power (1/10 of the maximum output voltage), the amplifier has 20 dB headroom left before clipping. A 250 watt amplifier would operate at nominal 2.5 watts, or a 100 watt amplifier at 1 watt, on average level passages in order to allow 20 dB for the loud peaks.

To operate this system, use only the controls on the console, and avoid levels that consistently peak the console's VU meter above the "zero" mark on its scale, or that peak the amplifier meters above a safe power level for the speaker system. Any level adjustments in the other devices in the system will upset this established gain structure.

To use this technique with any sound system, first design the required speaker system, and calculate the number of power amplifiers needed to safely operate the speaker system with adequate headroom. Then, choose the console, and other devices that feed the power amplifiers, and set up the system according to the above instructions.

Grounding

Grounding is an area of "black magic" for many sound technicians and engineers, and certainly for most casual users of sound systems. Everyone knows that grounding has something to do with safety, and something to do with hum and noise suppression, but few people know how to set up a proper AC power distribution system, and how to connect audio equipment grounds so that noise is minimized. This subsection of the manual won't make anyone an expert, but it does point out a few of the principles and precautions with which everyone should be familiar. Whether you read this material or not, before you start cutting shields and lifting grounds, read this warning:

WARNING

In any audio system installation, governmental and insurance underwriters' electrical codes must be observed. These codes are based on safety, and may vary in different localities; in all cases, local codes take precedence over any suggestions contained in this manual. Yamaha International Corporation shall not be liable for incidental or consequential damages, including injury to any persons or property, resulting from improper, unsafe or illegal installation of a Yamaha power amplifier or of any related equipment; neither shall Yamaha be liable for any such damages arising from defects or damage resulting from accident, neglect, misuse, modification, mistreatment, tampering or any act of nature. (IN PLAIN WORDS... IF YOU LIFT A GROUND, THE RESULTING POTENTIAL FOR ELECTRICAL SHOCK IS YOUR OWN RESPONSIBILITY!)

As a further caution, we advise you never to trust any potentially hazardous system, such as an AC power system of any type, just because someone else tells you that it's okay. Before you "trust your life", check things out yourself! People do get killed by faulty or improperly wired sound equipment.

WHAT IS A GROUND LOOP, WHY IS IT BAD, AND HOW IS IT AVOIDED?

The Ground Loop is perhaps the most insidious, widespread problem that turns up in one sound system after the next. A "ground loop" is a multiple electrical path between two or more components — a path formed by the ground wiring, the chassis of the components themselves, or by combinations of these two main elements. Electrical noise current (induced RFI and 60 Hz hum) that flows through the shield, chassis,

and/or AC power grounds can "loop" around from one piece of equipment to another. Instead of going directly to earth ground and disappearing, these noise currents (which act like signals) travel along paths that are not intended to carry signals. The currents, in turn, modulate the potential of the signal-carrying wiring, producing hum and noise voltages that can't be distinguished from program signals by the affected equipment. The noise is thus amplified along with the program material.

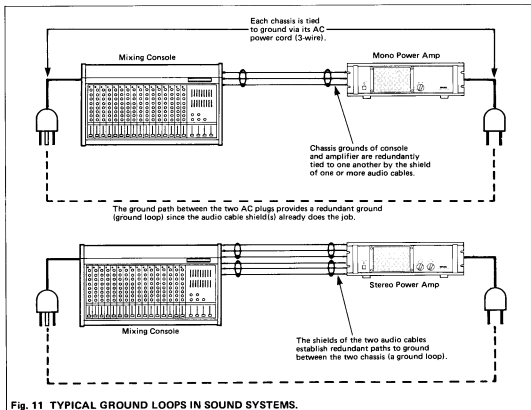

Ground loops often are difficult to isolate, even for experienced audio engineers. Whenever you hear hum from a sound system, there is a strong possibility that it is being caused by a ground loop. Sometimes, in poorly designed sound equipment (which include some very expensive equipment), ground loops occur **INSIDE** the chassis, and little can be done to get rid of the hum short of having a good audio engineer re-design the ground wiring inside; it's better to avoid this kind of equipment.

One myth about grounding is that you must ground the equipment to prevent noise from entering the system. Anyone who owns a portable cassette machine knows that simply isn't true. The main reason we ground a sound system is for safety; proper grounding can prevent lethal shocks. The next reason for grounding a system that includes AC powered equipment is that, under some conditions, proper grounding may reduce external noise pickup. While proper grounding won't always reduce external noise pickup, improper grounding can unquestionably increase external noise pickup!

The AC power cord ground (the green wire and the third pin on the AC plug) connects the chassis of electronic equipment to a wire in the wall power service that leads through building wiring to an "earth" ground. The earth ground is required by electrical codes everywhere, and can contribute to ground loops.

If there is only one path to ground, there can be no ground loop. However, one must look carefully. For example, suppose there is just one audio cable joining a console to a power amplifier . . . can there be a ground loop? Yes! A second ground connection, through the AC cables and the chassis of the two units, makes the "return" connection and, along with the audio cable shield, constitutes a continuous conducting loop for noise currents to flow. One commonly used method to break this ground loop is to "lift" the AC ground on the power amplifier with a two-wire to three-wire AC adaptor (leaving the loose green wire on the adaptor unconnected). This practice removes the AC safety ground, relying upon the audio cable to provide the ground, a practice that can be hazardous.

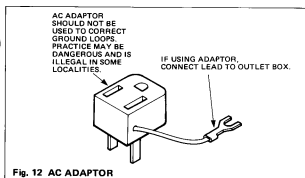

Here are some suggestions to minimize the safety conflict while avoiding noise caused by ground loops:

1. Don't lift the safety ground on any piece of equipment unless it demonstrably reduces noise levels.
2. NEVER defeat the AC safety ground on your console or any other piece of gear connected directly to your microphones. The microphones come first in grounding safety.
3. Try to plug all affected equipment into a common AC service. In fact, all sound equipment and related accessories such as guitar amps, keyboards, etc., should be connected to a common AC system to avoid safety hazards. Lighting, air conditioning, motors and so on should be connected to a completely different "phase" or "leg" of the main power distribution system for the facility.

BALANCE LINES AND GROUND LIFT SWITCHES

By using balanced signal lines between two pieces of sound equipment, you can lift (disconnect) the shield at one end (usually at the output) of an audio cable and thus eliminate the most likely path that carries ground loop currents. In a balanced line, the shield does not carry audio signals, but only serves to protect against static and RFI, so you can disconnect the shield at one end without affecting the audio signal on the two inner conductors of the cable, and with little or no effect on the shielding. Unfortunately, this is not a very practical solution to the ground loop problem for portable sound systems because it requires special cables with shields disconnected on one end.

CAUTION

Microphone cases typically are grounded to the shield of the cable, and connected to the console chassis via pin 1 of the XLR connector. If there is any electrical potential on any external equipment, such as a guitar amp chassis, then a performer who holds the mic and touches the other equipment can be exposed to a lethal electrical shock! This is the reason one should avoid "ground lift" adaptors on AC power connections if there is any other conceivable way to eliminate a ground loop.

Sometimes, you'll find pieces of audio equipment or accessories that are designed to anticipate ground loops. This equipment will include "ground lift" switches next to any XLR or three-wire (Tip/Ring/Sleeve) phone jack outputs. The ground lift switch makes and breaks the connection between the connector's shield and the chassis of the particular device. Ground lift switches are usually found on "direct boxes", which are used when an electric musical instrument is to be plugged directly into a console whose inputs are not designed to accommodate direct connection of such instruments (a direct box also includes a transformer or isolation amplifier).

Probably the best way to keep noise out of a microphone input is to start with a high-performance, low-impedance microphone and to connect it to a console's low-impedance, balanced (or "floating") input with a high-quality microphone cable that utilizes XLR connectors. Keep microphone cables as short as possible within the constraints of a performer's needs, and keep them physically separated from line-level (console output) cables, speaker cables and AC cables.

AC outlet wiring affects grounding and safety

Whether you are a technician or not, there are two items you should carry whenever you set up a sound system in a new location. One of these is a commercial outlet tester, the other is a neon lamp type AC voltage tester. These items are inexpensive and available at most hardware stores, electrical supply houses and some lighting stores.

The three-prong outlet tester will tell you if the outlet is properly wired. An improperly wired outlet may have its two AC wires reversed ("polarity reversal") or it may have a disconnected ground. ANY FAULT in the wiring of the AC outlet is potentially hazardous. Rather than take a chance with damage to equipment and possibly lethal shock, it is best to refuse to use a faulty outlet until it has been repaired by a licensed electrician.

HOW TO OBTAIN A SAFETY GROUND WHEN USING A 2-WIRE OUTLET

Two-wire AC outlets do not have a hole for the "safety ground" prong of a 3-wire power cord. To use one of these two-wire outlets you have to "adapt" it to the three-wire AC plug on your sound equipment with a two-wire to three-wire AC adaptor (Fig. 12). These adaptors can maintain a safe ground for the sound system IF you connect the loose green wire on the adaptor to a GROUNDED screw on the two-wire outlet. How do you know whether or not the screw is grounded?

1. Connect the adaptor's green wire to the screw on the two-wire outlet.
2. Plug the adaptor into the outlet.
3. Plug in your three-wire AC outlet tester into the adaptor. If the screw is grounded, your AC outlet tester will tell you. (Most three-wire AC outlet testers either have a "good" light, or they don't light at all on a good receptacle.)

If the screw is not grounded, the outlet tester will indicate this too. In this case, you must connect the adaptor's green wire to some other grounded screw in order to maintain a safe ground for your system. If the outlet tester shows a good ground but reversed polarity on your two-wire to three-wire adaptor, sometimes you can reverse the adapter in the outlet by pulling it out, twisting it a half turn and reconnecting it.

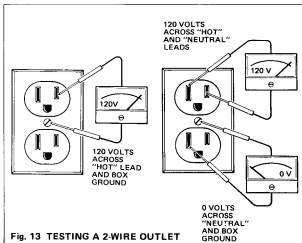

IMPROPERLY WIRED AC OUTLETS: LIFTED GROUNDS

A "lifted ground" condition exists if the ground or green wire from the outlet's safety ground is disconnected or missing. In older wiring, the heavy green wire was sometimes omitted from internal wall wiring in favor of letting the metal flex conduit or pipe suffice as the ground path from the electrical service entrance. Inspectors usually accept this approach, and normally there is no problem as long as the metal conduit in the wall is intact and all the screws holding the joints together are secure. However, a single loose screw in a conduit joint inside a wall can remove the safety ground of the next outlet box in the line (and all the subsequent boxes on that same line).

IMPROPERLY WIRED AC OUTLETS: LIFTED NEUTRAL

If the neutral becomes lifted at a power outlet, it is possible that items plugged into the outlet will be fed the full 220 to 240 volts available from the power service instead of the desired 110 to 120 volts.

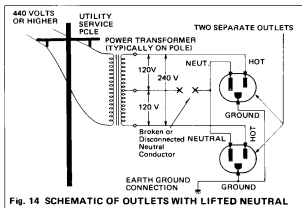

Such outlets may operate, but the voltage can swing from 0 volts to 220 or 240 volts AC (depending on the maximum voltage at the service entrance), creating a shock hazard and possibly damaging your equipment.

If a power amplifier is plugged into one socket of one of the two outlets with lifted neutral, and a rack of signal processing equipment is plugged into the other, fuses would probably blow upon turning on the system, and some of the sound equipment could be destroyed.

If you detect any voltage between the larger slot (white wire) in an outlet and the ground terminal (round third pin) when there is no load on that line, you should contact a licensed electrician to check it out.

WARNING

IN AC POWER WIRING, BLACK IS HOT, WHITE IS NEUTRAL—the opposite of most audio signal wiring and speaker wiring. It is safer to consider all AC wiring as potentially lethal. It is possible someone miswired the system, or that a short circuit has developed. Test the voltages yourself, and be safe.

Although the white wires (neutral) and the green wires (ground) in the AC wiring are technically at the same potential (voltage), and should measure the same potential using a voltmeter, the ground prong connections at the outlets are connected to the grounding bar that was driven into the earth as an additional safety precaution in case something should happen to the wires running from the service entrance transformer to the building or within the equipment itself. If a short should occur within the equipment, hopefully the electricity will find its way to ground via the safety ground, instead of via a person's body. When checking AC power lines at the outlet, be sure you have proper testing tools and some familiarity with the danger of shock hazards from AC power. Follow the diagram shown here, being careful not to touch metal with your hands or short the test leads together.

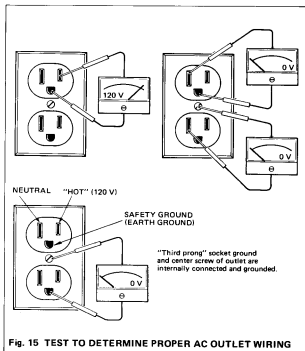

FIG. 15 TEST TO DETERMINE PROPER AC OUTLET WIRING

AC SAFETY TIPS

1. Get an AC outlet tester for your tool box.
2. Be conscientious. Use your tester on power lines, and use a neon voltage tester to check for voltage present between microphone and guitar amps, microphones and electric keyboard chassis, and so forth.
3. Use common sense. For instance, a clip-on ground lead may do the job on a lab bench, but it certainly is not safe for a sound system ground. AC power must be regarded with respect.
4. Don't use questionable power outlets; anticipate the worst, and always carry a long extension made of heavy gauge wire. A good extension should be made of #12-3 (12 gauge, 3 wires), and no longer than 15 meters (50 feet).
5. If you can't find suitable power at a venue, refuse to plug your equipment in. Besides posing a hazard, it could destroy your equipment. Don't risk it.

Speaker Wiring

USE THE APPROPRIATE WIRE

For speaker cables, use the largest practical wire size (the lowest gauge number). Speaker cables, especially for portable use, should be rugged. The type of wire normally used for heavy-duty AC power cables and utility extensions (such as for 240-volt industrial power tools) is a good choice; it has heavy rubber or vinyl outer insulation, stranded conductors, and is usually fairly flexible. Wire gauge is the most important consideration, especially for long speaker cables. Remember to always calculate the resistance based on twice the distance to the speaker since the signal must travel up one conductor and back the other to complete the circuit.

WIRE GAUGE	SPEAKER SYSTEM LOAD IMPEDANCE		
	4 OHMS	8 OHMS	16 OHMS
10 Gauge	-0.44 dB	-0.22 dB	-0.11 dB
12 Gauge	-0.69 dB	-0.35 dB	-0.18 dB
14 Gauge	-1.07 dB	-0.55 dB	-0.28 dB
16 Gauge	-1.65 dB	-0.86 dB	-0.44 dB
18 Gauge	-2.49 dB	-1.33 dB	-0.69 dB

TABLE 1. SIGNAL LOSS IN 30 M (100 FT) SPEAKER CABLE.

Table 1 shows nominal losses (in dB) for a 30 meter (100 ft) cable run of different gauges driving a 4, 8, and 16 ohm load. (Note: since there are 2 conductors, and the signal flows through both, the actual round trip cable run is 60 meters or 200 feet.)

For an "ideal" unchanging load, these relationships are logarithmic. However, for typical speaker impedances and cables, a linear calculation will yield a reasonably close approximation of the signal loss. Thus 15 meters of wire (50 feet) would give about half the loss shown on the chart, and so on. For example, ten feet of 10-gauge wire driving an 8-ohm studio monitor will produce a loss of 0.022 dB. If the wire's resistance becomes significant compared to the overall load impedance, heating will occur in the wire during high power operation.

Large diameter (small gauge number) wire is expensive, and long cables made from it are heavy. Rather than running long speaker cables, it is better to locate power amplifiers near speakers and run a line-level signal cable over the long distance to the amplifier. This approach eliminates most of the signal loss due to speaker cable's resistance so the speakers will be fed all the amplifier's power without the need for heavy cables. It can actually save money in many instances. Where speakers and power amplifiers are located far away from the signal source (be it a console or a preamp), "balanced line" signal cables are a wise choice.

Always use stranded wire for three reasons:

- (1) It is more flexible and less prone to metal-fatigue breakage.
- (2) If an end is nicked while insulation is being stripped for connection, only one or two strands will break, not the entire wire, and . . .
- (3) There is some evidence, though disputed, that higher frequency audio signals flow along the outside of each conductor (skin effect); if this is so, the more strands, the lower the effective cable resistance to high frequencies.

CAUTION

NEVER USE COIL CORDS FOR SPEAKER HOOKUP, not even temporarily. Coiled guitar type cords usually have higher internal resistance than the speakers themselves. High resistance is due to the thin wires used to keep the coil cords flexible. These cords will prevent most of the power from reaching the speakers. In high power operation, a coil cord can melt and cause a fire hazard. As a general rule, guitar-type connecting cords, both straight and coiled, make poor speaker cables.

CALCULATING SPEAKER SYSTEM LOAD IMPEDANCES

Several speaker components having the same power handling capability, sound dispersion angle, efficiency or other characteristic are often connected in groups to make a system that goes beyond the capability of the individual units in that system.

There are two basic ways to hook up speakers so that power is uniformly distributed and it remains relatively easy to calculate the resulting load on the amplifier. The easy way to figure how much power a group of speakers, or drivers, can handle is to multiply the power handling specification of one of the drivers by the number of drivers. That part of the process is always the same as long as all the connected drivers are identical.

It is not recommended, nor is it common practice, to place different types of bass drivers in a single enclosure, or to connect different types of bass drivers in series, or parallel because the power will not be distributed evenly among the drivers. This same reasoning also applies to the connection of various systems which have different rated impedances.

A group of speakers that are connected in series presents a higher impedance to the amplifier than any one of them alone; the total impedance is the sum of the individual impedances. A higher total impedance represents a lesser load to the amplifier, and consequently draws (or receives) less power.

If all the speakers connected in series are the same impedance, then the total impedance is the impedance of one speaker multiplied by the number of speakers. The power delivered to any one speaker is the total power delivered to the group, divided by the number of speakers. For example, if four eight-ohm speakers are connected in series, the total load

impedance is 32 ohms. An amplifier rated at 250 watts into 4 ohms would deliver 1/4 that power, or about 63 watts, into 32 ohms. Thus, one of the four speakers would dissipate 1/4 of that power, or just under 16 watts. (If the speaker impedances are dissimilar, the highest impedance driver receives the most power.)

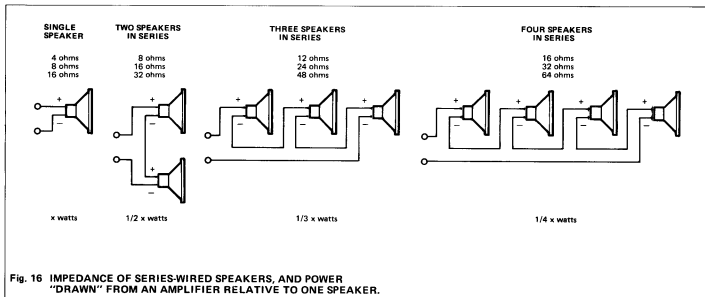

Speakers connected in parallel present a load to the amplifier that is lower impedance than the impedance of any one of the drivers. This represents a greater load to the amplifier, and also draws more power. Parallel wiring can be thought of as a pair of parallel wires where individual drivers are all connected across the two wires. If all the speakers are identical, then the total impedance of the array is simply the impedance of any one of the drivers divided by the number

of drivers. For example, three 16 ohm drivers connected in parallel represents a total load impedance of 16/3, or 5.33 ohms. Connected to an amplifier rated at 250 watts into 4 ohms, this load would draw about 188 watts. Thus, one of the four speakers would dissipate 1/4 of 188, or about 47 watts. In this case, the parallel wiring results in greater overall power delivered to the speakers.

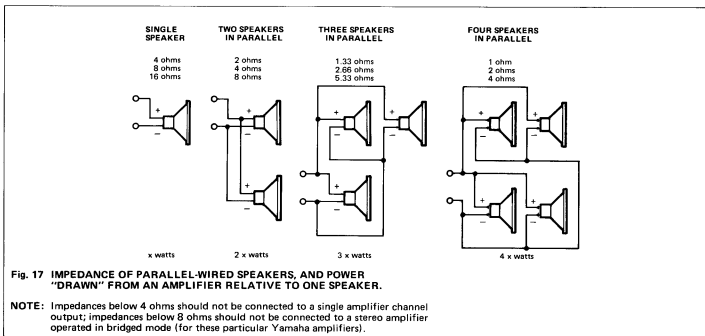

It is generally accepted that only drivers of the same impedance (ohms) are wired in parallel, but this is not necessarily the case. For 2 unequal impedances in parallel, use the following equation:

$$\text{TOTAL OHMS} = \frac{(a \times b)}{(a + b)}$$

Suppose a dual-channel amplifier is designed to drive a 4-ohm load connected to each channel. Driving 8 or 16 ohm loads does no harm, but produces less power since the amplifier behaves as a voltage source. Suppose the dual-channel amplifier is being used for a monaural program, and is connected to a pair of 8-ohm speakers. It will deliver the same number of watts using only one amplifier channel with the two speakers connected in parallel to the one output, as it will deliver with one speaker connected to each of two channels.

Theoretically speaking, any combination of parallel and series wiring is permissible in a speaker array as long as it results in the distribution of the same amount of power to each driver in a given system. Practically speaking, though, speakers that are connected in series do not perform the same as those connected in parallel. In simple terms, the reason is that the speakers connected in series operate with a worse effective damping factor than those connected in parallel. This can result in somewhat degraded bass performance. Furthermore, if any one speaker in a series circuit fails (open-circuit), the rest of the speakers connected in series with it will cease operating. For these reasons, it is generally better to use parallel connection for multiple speakers.

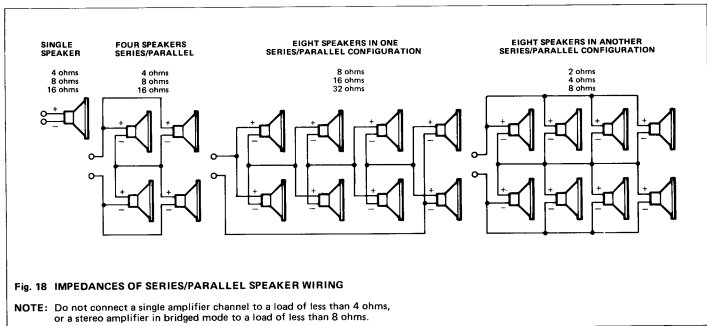

Once you have interconnected a group of speakers in a single enclosure (an array), you can consider that enclosure to be a single large speaker having the combined impedance and power handling characteristics of all the drivers (as calculated for their series/parallel arrangement). This is especially handy when a large number of cabinets are combined into a huge sound system. All you have to do is consider the impedance at the input terminals of the cabinet, not the impedances of each driver in each cabinet.

Distributed speaker systems and constant voltage lines

CONSTANT VOLTAGE (TRANSFORMER-COUPLED) DISTRIBUTED SYSTEMS A GENERAL DESCRIPTION

A distributed speaker system is one where many smaller speakers are used to cover large areas for paging and background music. This type of setup proves most efficient and controllable, and helps keep down the cost of the overall system. In large meeting rooms or halls with low ceilings, distributed speaker systems may be the only way to cover an audience uniformly. In large office buildings, hospitals, and other industrial installations, many small speakers are used in a similar distributed wiring scheme. In churches, distributed systems have been installed with speakers located on the pew backs so that the sound from individual speakers can be kept at low levels, thus avoiding problems with excess reverberation in the hall.

If a large number of typical (8-ohm) speakers were simply wired in parallel to the SPEAKER terminals of the amplifier, the overall load impedance would be very low (less than an ohm with more than 8 speakers), and the amp would be overloaded. Series wiring would raise the load impedance to an acceptable figure, but would subject the entire system to fail if just one speaker voice coil were to go "open circuit". A combination of series and parallel wiring would become quite complex, and would still not permit the installer to easily set different sound levels for individual speakers covering different zones. The way to overcome these difficulties without buying one power amp for every few speakers is to use a constant-voltage wiring scheme.

In a constant-voltage system, the amplifier is normally fitted with an output voltage step-up transformer. That transformer's output then drives one a pair of wires that are run to many speakers, each of which is fitted with a step-down transformer.

NOTE: High power dual-channel amplifiers operated in MONO bridged, such as the P2250, mode may be capable of driving a 70 volt line without the use of a step-up transformer. The P2250, for example, will deliver up to 63 volts in MONO mode, or nearly the 70 volt nominal, without a transformer. However, an output transformer does prevent the amplifier output from "seeing" the impedance dips at low frequencies which occur with many inexpensive speaker transformers. For this reason, we recommend the Yamaha commercial power amplifiers (P1150C, P1250C, P2150C or P2250C) for use with constant voltage speaker systems; these amps are designed for operation with optional output transformers.

A typical small transformer mounted to a typical ceiling speaker is rated at 5 watts (on its highest power tap). Such a speaker will actually draw 5 watts only when the speaker line is delivering 70 volts RMS. A 10 watt transformer like the type found on larger ceiling speakers will draw 10 watts when the audio line is at 70 volts RMS. Such a "70 volt line" is most commonly used with this type of distributed system. With the 70 volt line, any number of speakers can be used, up to the point where the total power that is drawn by all the speakers and transformers on that line equals the power output capability of the amplifier driving the line.

When using some output transformers, a 25 volt line can be run instead of a 70 volt line; such a system uses a center tap on the same 70 volt transformer, and simply delivers less power to the speakers because less voltage is delivered to the line. This provides a simple way to scale down the power to each speaker, and, if desired, to feed a greater number of speakers, depending on the requirements of the system.

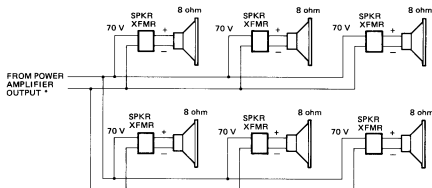

* Parallel-wired speaker/transformer distribution system may be fed directly from the amplifier output. Preferably, it will be fed by an optional output transformer. A 70 volt RMS line level will deliver the rated power from the speaker-mounted transformers. 25 volt or other line voltages will deliver less power. (Power is proportional to the square of the line voltage).

Fig. 19 A TYPICAL 70-VOLT DISTRIBUTED SYSTEM

MORE INFORMATION ABOUT THE TRANSFORMERS USED ON THE SPEAKERS

Most of the commercially available speakers for distributed use come with an attached line transformer that has several taps. The taps permit the installer to choose how many watts of power will be drawn by the individual speaker — or at least what percentage of the power available to the line will be used by the speaker.

Standard small 8-inch ceiling speakers usually have transformers that offer 1, 2, 3, 4, and 5 watt taps (or some variations ranging from 0.25 watts to as high as 100 watts for specialized high-power 70 volt lines). These standard taps afford a wide range of wiring possibilities, such as single 70 volt lines that have quiet and loud "zones" where some individual speakers' 1 watt taps are used, and others on the same line have their 5 watt or other taps used — any combination is possible as long as the total number of watts from adding up all the connected transformer taps totals no more than the available amplifier power.

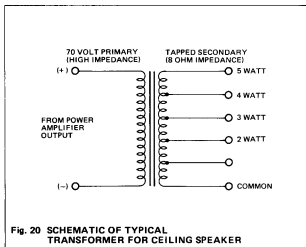

For example, if one 120 watt amplifier is used to feed a 70-volt line, then 24 individual drivers with their 5 watt transformer tap can be connected to the line and will deliver the full 5 watts each without overloading the amp. Thirty drivers with 4 watt taps, 60 drivers with 2 watt taps, or 120 individual drivers with 1 watt taps can all be attached to the single 70 volt line.

The impedance of very small, poorly made transformers tends to drop off at lower frequencies. This would tend to overload the power amplifier in the presence of low frequency program material at high levels. To avoid such problems without purchasing more costly transformers for individual speakers, sound system designers often specify a high pass filter at the amplifier. This reduces the low frequency content of program material fed to distributed speakers.

Larger, more expensive speakers can be used in distributed systems where high fidelity sound is important. For such systems, line transformers with excellent frequency response are available at a higher additional cost. These higher quality 70 volt line transformers are also used where very long speaker wiring must be used or where electrical safety considerations prevent connecting amplifiers directly to speakers. The better quality transformers are less apt to exhibit the low-frequency impedance drop, so the high pass filter protection may not be required.

How to calculate amplifier power output in bridged MONO mode

When one of the dual-channel amplifiers is operated in MONO mode, its outputs are wired in series, thereby doubling the amplifier output impedance. To avoid overloading the outputs, the minimum load impedance should be doubled. This might seem to "cancel" the advantage of the higher output voltage obtained by bridging, but the equation below shows how power is doubled, despite the higher load impedance:

$$W = E^2/R$$

or,

watts = volts squared, divided by ohms

If an amplifier were rated at 100 watts per channel into 8 ohms, its RMS output voltage would be 28.28 volts. If each channel could deliver 28.28 volts into 8 ohms during normal operation, in bridged operation, the output would be 56.56 volts into 16 ohms. Here are the calculations of total output power for these two situations:

NORMAL (STEREO) MODE

$$P = (28.28 \times 28.28)/8 = 800/8 = 100W$$

(per channel in normal operation; given two channels, this equals 200 watts total)

BRIDGED (MONO) MODE

$$P = (56.56 \times 56.56)/16 = 3200/16 = 200W$$

(total power output for the two channels is the same here as in stereo mode at half the load impedance)

Bridged operation of the amplifier thus makes it possible to drive higher impedance speaker systems with the full output power of the amplifier. This mode extracts the maximum output VOLTAGE available from the amplifier for driving loads that require more voltage: a 70 volt distributed speaker system can be driven without need for an output transformer.

MULTI-AMPLIFIED SPEAKER SYSTEMS (Biamping, triamping and so forth)

The conventional speaker system (in this context) feeds the full range program signal to a single power amplifier, and the speaker enclosure(s) connected to that amplifier each contains several drivers and a built-in high-level crossover to divide the amplifier output. An alternate approach is the multi-amplified system. Here, the speaker enclosures have no built-in crossover network. Instead, a single low-level crossover divides the program at line level, feeds the different bands to multiple power amplifiers, and the output of each amplifier goes to a different driver (or group of similar drivers) in the speaker system. When two amps are used, the system is said to be "bi-amplified," three amps make it "tri-amplified" and so on.

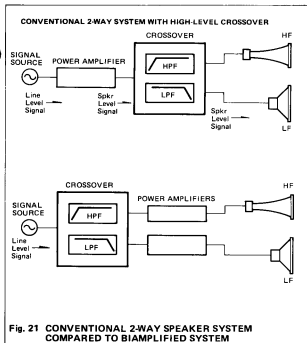

Fig. 21 CONVENTIONAL 2-WAY SPEAKER SYSTEM COMPARED TO BIAMPLIFIED SYSTEM

By using this multi-amplifier approach, the overall system headroom can be increased without necessarily increasing overall amplifier power capacity. How is that possible? When a single amplifier has to reproduce the full audio spectrum, the low frequencies can "use up" the headroom of the amplifier (remember, it typically takes more power to reproduce low frequencies at a given sound level than it does to reproduce high frequencies). When higher frequencies share the available amplifier power, they "ride" along on the low-frequency waveforms. As a result, they are subject to being truncated, or "clipped," even though the low or high frequency signal alone would not be sufficient to cause clipping. Although the low frequency portion of the signal may not yet have reached the clipping level, the peaks of the superimposed high frequency signal try to push the amplifier beyond the voltage limits of its power supply. In order to eliminate the problem with a conventional full-range amplifier/high-level crossover system, it is necessary to turn down the volume or to use a larger power amplifier.

Separating the program into high and low frequency bands with a low-level crossover and feeding each band to a different amplifier means that the treble will not "ride atop" the bass. A moderately high power amplifier will then be sufficient to reproduce the bass without clipping, while a smaller power amplifier can be used to reproduce the treble without clipping. (Remember, bass frequencies require more power to be perceived at the same level as higher frequencies, and high frequency drivers also tend to be more efficient, which is why a smaller amp is OK for the treble portion of the program.) The numbers work out, particularly in larger sound systems, such that the combined power handling capacity of all amplifiers in the multi-amped system can be less than the power capacity which would be required with a sound system using full-range amplification. A further cost advantage is realized in large systems with numerous speakers because one no longer has to pay for an expensive high-level crossover for each speaker enclosure or cluster; one electronic crossover can feed numerous amplifiers for each frequency band.

Multi-amped systems also tend to sound better should clipping occur. Consider the typical case of a microphone inside the kick drum, subject to 130 dB SPL peaks and pushing the power amplifier(s) "to the wall." With a full-range system, clipping caused by the drum may be very audible since the higher frequency harmonics generated by the clipping are fed through the crossover to midrange and high frequency drivers, which do an excellent job of reproducing this distortion. With a multi-amplified system, if the same drum beat were to cause the low frequency amplifier to clip and generate annoying higher frequency harmonics (distortion), those higher frequencies can only reach the low frequency driver. Since the low frequency driver is less sensitive to higher frequencies and does not reproduce them well, less distortion gets to the listener's ears. The mid and high frequencies, which are reproduced by another amplifier (which is not clipping), remain clean.

CAUTION

When a power amplifier is connected directly to a high frequency compression driver, as it is in a multi-amplified system, there is the possibility that clipping of that amp can damage the driver. That's because the clipped amplifier will produce full bandwidth distortion products, including low frequencies which can rapidly damage diaphragms due to over-excitation. For this reason, some sound contractors and rental companies (who are not always able to control proper use of their systems) like to install protection capacitors between the amplifier and the high frequency drivers.

With multi-amplified systems, it is also possible to place a compressor/limiter at each output of the low-level crossover. In this way, the compressor can "level" a given segment of the low-frequency band when the signal level gets too high, or of any other band, and the compression will not "duck" the entire program. Each compressor/limiter can be adjusted for a different threshold. With more sophisticated compressor/limiters, the time constants can be tailored to each frequency band so as to minimize compression-induced harmonic distortion. This approach makes it possible to operate the sound system at higher average levels, without suffering from "over-compressed" sound and without encountering clipping, thus further increasing the useful dynamic range of the system without using more amplifiers or speakers.

How crossover networks operate and what they do

A crossover network (crossover) consists of at least one pair of filters; the low pass filter rolls off higher frequencies so they don't reach the low frequency driver, and the high pass filter rolls off lower frequencies so they don't reach the high frequency driver. More complex crossovers have additional filter pairs to further divide the signal into more "bands" to feed additional drivers. While we sometimes speak of a "crossover point," in fact crossovers are not capable of producing abrupt "brick wall" slopes to divide the frequency spectrum. Instead, the "crossover point" is a reference frequency at the middle of a region of overlap between two drivers, where both are reproducing the same frequency, and neither is producing full acoustic output.

To visualize how a crossover functions, consider a simple two-way speaker system having one woofer, one tweeter, and a built-in crossover network. The power amplifier connections on the speaker system go to the input of the built-in crossover. The low frequency output of that crossover is connected to the woofer, and the signal from this output "rolls off" gradually as the frequency increases; the low frequency output has been processed by a low pass filter which blocks unwanted high frequencies from reaching the woofer. The high frequency output of the crossover is connected to the tweeter, and the signal from this output increases gradually

as frequency increases; the high frequency output has been processed by a high pass filter.

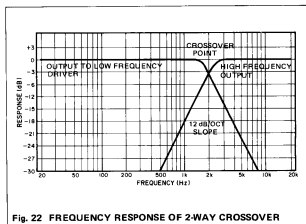

Fig. 22 FREQUENCY RESPONSE OF 2-WAY CROSSOVER

The low pass and high pass filter "cutoff" frequencies are usually the same or very nearly the same, so there is an area of overlap where both drivers are reproducing the same frequencies. Generally the "crossover point" lies in the middle of this "crossover region," and is that frequency where the power fed to the woofer is down about 3 dB (half the power) relative to the power at a frequency well below the crossover region and where the power fed to the tweeter is about 3 dB below the power fed to it at a frequency well above the crossover region. Signals whose frequency happens to be at the crossover point are reproduced equally by the woofer and tweeter, so the combined "half power" signals in each driver add up to full power overall. This is done to yield smooth frequency response — at least it's supposed to do so in theory.

Given its function, you can understand why a crossover network is also known as a "dividing network" or a "frequency dividing network." Two-way, three-way and four-way crossovers all operate on the same principle, but with fewer or more outputs; a different crossover point separates each pair of outputs.

The difference between low and high level crossovers

Crossover networks can be placed in either of two locations in the signal path of a sound system. The most common location for a crossover in consumer "hi-fi" speakers or packaged speaker systems is inside the speaker enclosure. In this case, the crossover network divides the output of the power amplifier just before it is fed to the individual drivers. Such crossover networks are called "high level" since they divide speaker-level signals. They are also called "passive" because they require no power source to operate.

The circuit of a passive, high-level crossover network typically consists of inductors (coils) and capacitors, but no transistors or integrated circuits. When high power operation is involved, the coils in the passive crossover can heat up, increase their resistance, and create noticeable power loss to the drivers; larger, more expensive coils help, but don't eliminate the losses. Good quality, passive high-level crossovers can cost several hundred dollars, weigh 10 to 25 pounds each, and one such unit will be required for each speaker enclosure.

The other location for a crossover network is just before the power amplifiers. In this case, the crossover network divides the output of the console (or other line-level signal source) just before it is fed to two or more channels of power amplifier, which, in turn, feed the speakers (drivers) in different bands of a speaker system. Such crossover networks are called "low level" since they operate with line-level signals rather than with the output of power amplifiers.

While low-level crossovers can be passive, most are "active," which means they require a source of power for their internal circuitry. Since the expression "active, low-level crossover network" is awkward, the term "electronic crossover" is more widely used.

When fed by a low-level crossover network (passive or active), each power amplifier is used to drive just one band of frequencies — one type of driver. In a two-way speaker system, for example, one amplifier is fed bass frequencies, and its output goes to the woofers, while another amplifier is fed higher frequencies, and its output goes to high frequency compression drivers.

This approach, using a low-level crossover to feed different bands of frequencies to two or more amplifiers is called "multi-amping." Specifically, a two-way multi-amped system is said to be "bi-amplified," a three-way system is "tri-amplified," and so on. There are numerous advantages to multi-amped systems, as compared to systems where a single amplifier is fed full range signals and a high-level, passive crossover network divides the amplifier output; the sound quality can be improved, overall amplifier power requirements can be less for a given amount of headroom, and total system cost and weight can be reduced. These benefits are especially important with large-scale sound systems.

The pros and cons of low level and high level crossovers

Passive, low-level crossovers are constructed with small inductors and capacitors in a metal box with connectors on it. The major drawback of passive low-level crossovers is their fixed characteristics; neither the crossover frequency nor the "slope" (the rate at which the internal filters roll in and out, in dB per octave) can be changed easily, unless many more components are added, which eliminates the cost advantage of the passive circuit. Passive low-level crossovers are used primarily where they are designed to complement a specific speaker system; since exact characteristics are known, no adjustability is required.

More often, however, low-level crossovers rely upon active electronic circuits to serve as filters. Because an IC, a capacitor and a resistor (plus a few peripheral components) can serve the same electronic function as an inductor, electronic crossover networks do not need to use inductors. Without inductors, it becomes feasible to provide an inexpensive control that alters the value of the electronic "inductor equivalent" circuit. This makes it relatively simple to adjust the crossover frequency, as well as to alter the slope or steepness of the filters.

Large, low-loss inductors of copper wire (the type used in good high-level crossover) are very expensive. This is why smaller, iron-core copper inductors or air-core copper inductors of marginal size are often used in commercial high-level crossovers — they save money. Such inductors produce greater distortion at high power levels. Worse yet, if the signal level exceeds that for which the crossover was designed, the inductors can saturate; they stop being inductors, crossover characteristics are suddenly and drastically altered, and the result may be severe distortion, and even "blown" drivers. Using a low-level crossover (passive or active) instead of a high-level crossover network avoids these potential sources of distortion and driver failure. Moreover, by using a low-level crossover, the series resistance of the large inductors in a high-level crossover is removed from the signal path to the drivers so the amplifier output impedance is no longer "swamped" and the effective damping factor increases.

Despite their advantages, low-level crossovers are not always the best choice. High quality speaker systems that come equipped with a built-in passive, high-level crossover will often do an excellent job in small to medium sized meeting rooms and in small clubs. A passive, high-level crossover also may be the best choice for a large, very efficient speaker system that is not expected to be used at extremely high

power levels. This type of crossover also makes sense if it is part of an existing speaker system that is doing the job satisfactorily. Finally, if only one amplifier channel is available to drive a speaker system, then a passive, high-level crossover is the only choice (unless one omits the crossover and uses a wide range speaker instead).

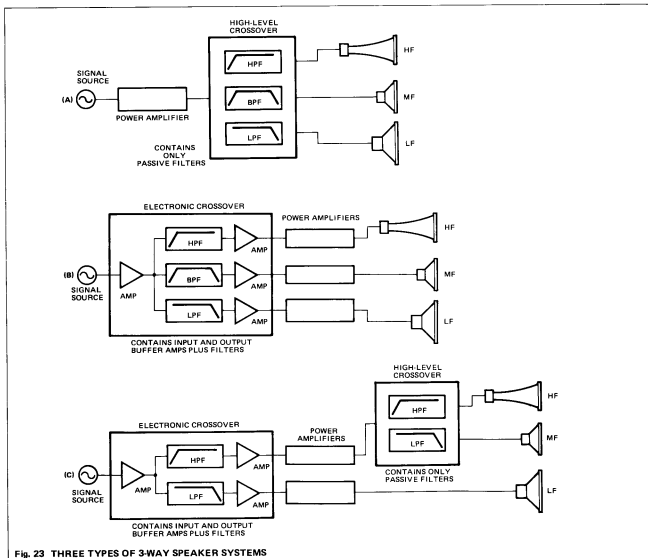

The meaning of various amplifier power rating methods

There are a number of different ratings or specifications that describe amplifier power. A given amplifier's specifications can vary by a factor of 2, 3 or 4 depending on the method used. It is important to understand just what you are reading when you see a power rating. A number of years ago, the United States Federal Trade Commission (FTC) established standard methods of rating amplifiers sold in the consumer (Hi-Fi) market to avoid the abuse of non-technical consumers by amplifier manufacturers who cited misleading or meaningless tests to persuade consumers that their amplifiers were more powerful than others. However, the FTC ratings themselves are simplistic and do not necessarily describe the "real world" performance of an amplifier. Since professional sound system designers can understand and make better use of several types of power ratings, these other ratings continue to be used.

Amplifiers intended for professional use are not required to carry FTC ratings (though some do, anyway, and these amps are measured after meeting the FTC pre-conditioning criteria, which tends to cause significantly more heating than full power operation.)

PEAK POWER

This is a measurement of the maximum undistorted power an amplifier can deliver to its load. Usually the load specified in such measurements is a non-reactive, laboratory load resistor (an ideal load). The test is usually done with one channel operating if the amplifier is a 2-channel model, and with a 1000 Hz sine wave input signal (i.e., a pure tone in the middle of the audio frequency spectrum). Peak Power is useful to determine the ability of the amplifier to reproduce peaks and transient signals that occur in musical program material. Since Peak Power is calculated using the peak-to-peak (or zero-to-peak) output voltage instead of the RMS output voltage of the amplifier, the peak rating can be several times higher than the Continuous Average (RMS) power even if there is no difference between the maximum and continuous output power levels.

CONTINUOUS AVERAGE SINE WAVE POWER (RMS POWER)

"Continuous Average Power" used to be known as "RMS Power." "RMS" is an abbreviation for "root mean square," a mathematical term. The RMS value of a sine wave signal is the peak value multiplied by half the square root of two; the RMS value cannot be so easily computed for complex waveforms. RMS ratings are convenient because the RMS voltage or current value of an AC or audio signal, when applied to a resistor, will accomplish the same heating as an equivalent DC voltage or current, so one can measure RMS power by measuring the heating of a resistor (though this is seldom done in practice).

Continuous Average Power ratings are used in amplifier testing as a convenience; test equipment measures the RMS values of AC signals. Mathematically, there is no such thing as "RMS Power." If RMS current is multiplied by RMS voltage, the result is NOT RMS power. Instead, power is generally calculated squaring the RMS voltage and dividing the result by a given load impedance; such calculations yield "Average power," not "RMS power." "Average sine wave power" is the proper way to express what many people think of as "RMS power."

IHF POWER & DYNAMIC HEADROOM (MUSIC POWER)

The IHF (Institute of High Fidelity), a trade organization, defined a power rating method that is essentially the same as "Continuous Average Power" or "RMS Power." They also defined a secondary rating known as "Dynamic Headroom." The Dynamic Headroom of an amplifier is based on a 20 millisecond, 1 kHz burst of higher power within a half second after operating for 480 milliseconds at the nominal level (approximately the same as the old "music power" method). Instead of specifying a value in watts, however, the IHF calculates the ratio of that midband peak burst power output to the continuous average power output and states the result in dB of Dynamic Headroom.

Given two amplifiers with equal continuous average power ratings, the amplifier with a larger dynamic headroom specification may sound louder – if the difference is sufficient. About 3 dB of difference is needed in order to hear a clearly audible advantage. For example, an amplifier rated at 100 watts average power, and having 3 dB of dynamic headroom, would probably have carried an old-style music power rating of 200 watts.

PROTECTION FOR SPEAKERS

Theoretically, power amplifier is capable of damaging speakers in many ways. Better amplifiers, such as these Yamaha amps, are designed to eliminate some of these damage modes.

Output relay

A turn-on transient (a low frequency “thump”) may occur as the power supplies in signal processing equipment activate internal circuits, but before the circuits reach a stable operating status. These “thumps” are then amplified by the power amp. The safest approach here is to disconnect the speakers from the amplifier until all equipment has stabilized. In these amplifiers, a relay keeps the amp output disconnected until after power has been on a few seconds and everything is stable. This protection only works, however, if you turn on the amplifier LAST — after first turning on the console, electronic crossover, and any signal processing equipment.

If DC were to appear at an amplifier's output, it would cause speaker voice coils to move to one position and stay there, which can quickly lead to voice coil overheating and premature failure of the speaker. Even relatively low levels of DC can cause this problem. DC can appear at a direct coupled amplifier's output when the input signal has just a few millivolts of DC offset; in AC coupled amplifiers, like these Yamaha amps, it is conceivable that DC would appear with asymmetrical, very low frequency input signals. High DC levels, as might be caused by a short between the power supply rails and the output, can instantly destroy a speaker suspension from over-excitation, followed by voice coil burn-out. For this reason, circuitry in the amplifier senses the presence of any significant DC component at the output (more than 2 volts), and opens the speaker relay immediately. When this happens, the front panel PROTECTION LED turns on. Given that the average 8-ohm speaker has a DC resistance of about 5 ohms, this means that the relay would shut down the output before so much as 1 watt of DC power reached the speaker load.

Current limiting

If a short circuit in the speaker or cable or a very low impedance speaker load overloads the amplifier, current limiting circuitry in the amplifier prevents excessive power from being delivered to the load.

HINT

USE THE RIGHT TYPE AND NUMBER OF SPEAKERS. The best speaker protection is obtained using amplifiers of sufficient power to avoid clipping, speaker components designed to handle large amounts of power, and using these speakers within their rated frequency band. In other words, don't plan to push any components to their absolute limits if you expect reliability.

Speaker fuses

Fuses offer protection against known currents that flow for a certain amount of time — two criteria that cannot be established for most musical signals. Even if every note were at the exact same volume (it's possible with a lot of compression), the changing frequencies themselves will cause changes in the current flowing through the speaker voice coil. To carefully calculate the power level which should blow a protection fuse, you have to use a given impedance, say 8 ohms. However, speaker loads are frequency dependent, and the fuse may regularly blow when a note is played that corresponds to the minimum impedance of the speaker (say 5 ohms instead of the assumed 8-ohm rating).

It may seem that the correct fuse has been selected because no program frequency causes it to blow ... until a long-time surge of higher-than-average power is sent to the speaker. Such surges can occur if a performer holds the head of a mic and induces feedback, or if a keyboard player leans on a particular synthesizer note for “effect.” Incidentally, while slo-blo fuses offer a little bit better protection from such surges, they do so at the cost of poor voice coil protection; they are too slow to protect compression drivers and tweeters against high power transients.

Fast blowing fuses can be used to prevent amplifier DC faults from destroying speakers in the event an amplifier “goes DC” (which is not likely due to protection circuits in the amplifier). If you do wish to use fast blowing DC fuses, select a current rating that will pass the speaker's rated power handling capacity. If the driver is rated at 200 watts and 4 ohms, that corresponds to 7.07 amps (current = square root of power divided by impedance). If the speaker is a multi-way system containing a high level passive crossover, then system power capacity for the entire system should be used in the calculation. Remember that while the fuse adds a certain amount of protection for the woofer; it offers little protection for a compression driver or tweeter in the same system because those component are generally capable of handling less power than the woofer, and the amount of padding for the high frequency drivers provided by the crossover may or may not balance the decreased power handling capacity of those drivers.

In general, we don't recommend fuses for speaker protection.

Compressor/limiters

A limiter can be used to prevent clipping — to reduce the level of the signal so it does not push the amplifier to the point of clipping. In this way, the limiter protects the speakers from having to dissipate excessive heat and it subjects them to less mechanical stress. By avoiding clipping of complex waveforms in the high frequency amp of a biamplified or triamplified system, the limiter can avoid compression driver damage from clipping-generated low-frequency energy. A limiter can also prevent a sudden loud transient, as from a dropped microphone, from tearing out a woofer suspension. Thus, when carefully adjusted, a limiter can protect speakers.

Improper adjustment can do speakers more harm than good. An excessively compressed program, for example, may raise the average power to the point where thermal damage occurs. Remember, compression reduces headroom. A 250 watt amplifier operated with 20 dB of headroom feeds an average of about 2.5 watts to the speakers. Add 17 dB of compression, and the average power may come up to 125 watts. Be sure you know what you're doing if you use a compressor/limiter, and use a security cover where appropriate to keep unauthorized fingers off the controls.

Equalizers and filters

Equalizers can be used to reduce the amount of "unnecessary" power dissipation in the speakers. If the amplifier power is "used up" reproducing unnecessary low frequencies, then the amplifier will reach the clipping point that much sooner, causing more distortion on loud program peaks. What do we mean by "unnecessary" frequencies? For instance, by rolling off the bass response in a microphone that is used for a flute, the intended signal is not compromised, but leakage from nearby drums, stage rumble and wind noise are prevented from reaching the speakers. Along the same lines, it is advisable to use band-limiting high pass and low pass filters to block inaudible frequencies from the speakers. Many consoles, crossovers and equalizers include high pass filters with "turnover points" of from 20 Hz to 80 Hz, and these should be used (and set at the highest practical turnover point) whenever possible.

Another important aspect to using a high pass filter is that low frequency driver (woofer) suspensions are not overstressed by being forced to reproduce noise and spurious signals. Still another benefit is that Doppler distortion is reduced. This distortion, named for the Doppler effect, is a form of intermodulation induced when a speaker cone is simultaneously reproducing treble and bass notes. Given bass and treble note of the same volume level, physical laws dictate that the cone must move as much as 4 times further (which requires twice the power) for every octave lower in frequency. The travel of the cone as it reproduces the bass notes causes the treble notes which "ride on the cone" to

move up and down in pitch, much like a train whistle changes pitch as the train passes by the listener. This Doppler distortion (intermodulation sidebands) is reduced by blocking unnecessary low frequencies at the amplifier input.

High frequency driver protection networks (filters)

A compression driver or tweeter can be quickly destroyed by transient DC surges, DC shifts in amplifier output due to non-symmetrical waveforms, or turn-On/turn-Off "thumps" from system electronics. While the Yamaha amplifiers provide DC protection in the form of an output relay, there is no protection from somebody mis-wiring the low frequency amplifier of a multi-amped system to the high frequency driver (or misconnecting the electronic crossover network). Such protection can only be provided by carefully checking a system before applying full power, and perhaps by protecting the drivers themselves. For this reason, we discuss this alternate method to protect compression drivers.

One can insert a capacitor in series with the cable to the power amplifier, and possibly a resistor shunt across the driver. This circuit constitutes a half section filter. Even with a multi-amplified system, such protection may be necessary to prevent low frequency energy from damaging the diaphragm or suspension due to over-excitation. The low frequency energy can reach the driver in a multi-amped system if it is caused by amplifier clipping (see note below).

NOTE

Clipping a single sine wave generates only harmonics that are higher in frequency than the clipped signal. However, when two sine waves are simultaneously clipped, they not only produce higher frequency harmonics, they also produce intermodulation products which include lower frequency components. When complex musical signals are clipped, it is actually possible for full-bandwidth energy to be generated. The extent of this effect depends on the amplifier itself and the degree to which it is overdriven — and some amplifiers exhibit better behavior than others.

When constructing the protection network, select a capacitor which is rated at a minimum of 200 volts. Non-polarized mylar, polystyrene, polypropylene, motor-start or oil-filled types are preferred, but may not be available in high values, so they may have to be paralleled with other types of capacitors. The value should be chosen to yield a high pass frequency which is an octave below the setting of the electronic crossover's high-pass frequency for the driver being protected.

NOTE

When the speaker system includes its own passive, high-level crossover network, this protection capacitor is not necessary since one is already provided in the crossover network. Multi-amped speaker systems that include low-level (passive or active) crossover networks that are ahead of the power amp benefit from this type of protection for the driver(s). The resistors are used in addition to the capacitor to damp the resulting resonant circuit (caused by the inductance of the driver and the protection capacitor); such a resonant R-L circuit could actually deliver more voltage to the driver at certain frequencies than is present at the amplifier output!

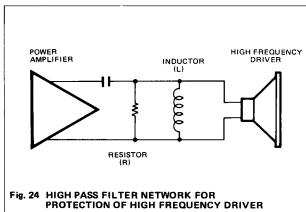

Fig. 24 HIGH PASS FILTER NETWORK FOR PROTECTION OF HIGH FREQUENCY DRIVER

This circuit can provide a 12 dB/octave roll-off. The inductor constitutes a short circuit for DC components, so in the event of a catastrophic amplifier failure which charges the capacitor, the inductor blocks the low frequency components from reaching the driver. The equation for a constant K network is $X_L = 2 \pi F L$, or $X_C = \frac{1}{2 \pi F C}$, where X_C is the driver impedance and F is the frequency.

In order to determine the value of the "blocking" capacitor in microfarads, use the equation below, based on the filter corner (-3 dB) frequency equation:

$$C = 500,000 / (\pi \times \text{frequency} \times \text{impedance}) = \frac{0.159}{FZ}$$

This equation will give you a 6 dB per octave high pass filter whose -3 dB point is at the frequency specified in the equation. If you want the filter to commence an octave below the crossover frequency, be sure to use that lower frequency in the equation. These capacitors will end up being quite large and fairly expensive, but in the long run, can prove worthwhile to protect drivers, especially expensive compression drivers.

The resistor R should be about 1.5 times the driver's rated impedance. For example, use a 12 ohm resistor for an 8 ohm driver. The power rating of both resistors should, preferably, be equal to the driver's power rating. Bear in mind that the resistor, while it damps the resonant circuit, also reduces the effective driver efficiency and places a greater load on the amplifier. For example, an 8 ohm driver in parallel with a 12 ohm shunt resistor constitutes a 4.8 ohm load. Two of these driver/filter circuits in parallel constitute a 2.4 ohm load on the amplifier, not the 4 ohm load that one might casually assume if only the driver impedances are considered. Thus, it may be a good idea to use 16 ohm drivers.

SPECIFICATIONS

P1150

Output Power Specs meet FTC preconditioning criteria	OUTPUT SPECIFICATIONS			
	8 ohms		4 ohms	
	20Hz - 20kHz	1kHz	20Hz - 20kHz	1kHz
Continuous sine wave output power at less than 0.05% THD	100 W	105 W	150 W	165 W
Total Harmonic Distortion (THD)	$\leq 0.007\%$ @ 55 W	$\leq 0.003\%$ @ 55 W	$\leq 0.01\%$ @ 75 W	$\leq 0.005\%$ @ 75 W
Intermodulation Distortion (IHD) 60 Hz & 7 kHz 4 : 1	$\leq 0.005\%$ @ 55 W		$\leq 0.01\%$ @ 75 W	
Power Bandwidth (@ THD $\leq 0.1\%$)	10 Hz to 100 kHz @ 55 W		10 Hz to 100 kHz @ 75 W	
Frequency Response (1 watt output)	+0, -1 dB, 10 Hz to 50 kHz			
Damping Factor	≥ 110 @ 1 kHz		≥ 55 @ 1 kHz	
Slew Rate	± 50 volts/microsecond full swing			
Signal-to-Noise (Input shorted)	≥ 110 dB, -6 dB/octave LPF @ 12.47 kHz ≥ 115 dB, IHF-A network			
Residual Noise (Input ATT @ minimum)	≤ -80 dBm, -6 dB/octave LPF @ 12.47 kHz ≤ -90 dBm, IHF-A network			
Input Impedance	≥ 15 kohms, balanced or unbalanced (ATT @ max)			
Sensitivity	+4 dBm (1.23 V rms) for nominal output (4 ohm load)			
Voltage Gain	26.0 dB			
Indicators	Signal: Green LED turns on when signal present at output is at or above 2 volts RMS (20 Hz - 20 kHz). Clipping: Red LED turns on when THD $\geq 1\%$. Protection: Red LED turns on when protection or muting is on. Pilot: Red LED turns on when power is on.			
Protection Circuits	Muting: Output muted 6 seconds (± 2 sec.) after power is on. DC sense: Output shut off if +2V DC sensed at output. Thermal: Output shut off if heat sink temp. ≥ 85 degrees C. Current Limiter: Output reduced if load ≤ 2 ohms.			
Fan Circuit	Fan is normally at low speed; when heat sink reaches 60 degrees Centigrade, fan goes to high speed; then resets to low at 45°C.			
Controls	Front: 32 step Input Attenuator; 0 to -20 dB in 1 dB steps, -20 to -30 dB in 2 dB steps, then -33, -37, -42, -50, -60 dB, and infinite attenuation. Push On/Push Off POWER switch.			
Power Requirements	120V AC, 60Hz U.S. & Canadian models 220/240V AC, 50/60Hz General (and other) models			
Power Consumption	250W (300VA) U.S. & Canadian models 400W General (and other) models			
Weight	28.6 lbs (13 kg)			
Dimensions	Width: 18-7/8 inches (480 mm) Height: 5-1/4 inches (132 mm) Overall Depth: 16-3/4 inches (423 mm) Depth Behind Front Panel: 15-1/8 inches (384 mm)			
Accessory	Rubber cap to discourage unauthorized or accidental changes in setting of input attenuator (included).			

P1250

Output Power Specs meet FCC preconditioning criteria	OUTPUT SPECIFICATIONS			
	8 ohms		4 ohms	
	20Hz – 20kHz	1kHz	20Hz – 20kHz	1kHz
Continuous sine wave output power at less than 0.05% THD	170 W	185 W	250 W	265 W
Total Harmonic Distortion (THD)	$\leq 0.007\%$ @ 85 W	$\leq 0.003\%$ @ 85 W	$\leq 0.01\%$ @ 125 W	$\leq 0.005\%$ @ 125 W
Intermodulation Distortion (IHD) 60 Hz & 7 kHz 4 : 1	$\leq 0.005\%$ @ 85 W		$\leq 0.01\%$ @ 125 W	
Power Bandwidth (@ THD $\leq 0.1\%$)	10 Hz to 100 kHz @ 85 W		10 Hz to 100 kHz @ 125 W	
Frequency Response (1 watt output)	+0, -1 dB, 10 Hz to 50 kHz			
Damping Factor	≥ 110 @ 1 kHz			> 55 @ 1 kHz
Slew Rate	± 50 volts/microsecond full swing			
Signal-to-Noise (Input shorted)	≥ 110 dB, -6 dB/octave LPF @ 12.47 kHz ≥ 115 dB, IHF-A network			
Residual Noise (Input ATT @ minimum)	≤ -80 dBm, -6 dB/octave LPF @ 12.47 kHz ≤ -90 dBm, IHF-A network			
Input Impedance	≥ 15 kohms, balanced or unbalanced (ATT @ max)			
Sensitivity	+4 dBm (1.23 V rms) for nominal output (4 ohm load)			
Voltage Gain	28.3 dB			
Indicators	Signal: Green LED turns on when signal present at output is at or above 2 volts RMS (20 Hz – 20 kHz). Clipping: Red LED turns on when THD $\geq 1\%$. Protection: Red LED turns on when protection or muting is on. Pilot: Red LED turns on when power is on.			
Protection Circuits	Muting: Output muted 6 seconds (± 2 sec.) after power is on. DC sense: Output shut off if $\pm 2V$ DC sensed at output. Thermal: Output shut off if heat sink temp. ≥ 85 degrees C. Current Limiter: Output reduced if load ≤ 2 ohms.			
Fan Circuit	Fan is normally at low speed; when heat sink reaches 60 degrees Centigrade, fan goes to high speed; then resets to low at 45°C.			
Controls	Front: 32 step Input Attenuator; 0 to -20 dB in 1 dB steps, -20 to -30 dB in 2 dB steps, then -33, -37, -42, -50, -60 dB, and infinite attenuation. Push On/Push Off POWER switch.			
Power Requirements	120 V AC, 60Hz U.S. & Canadian models 220/240V AC, 50/60Hz General (and other) models			
Power Consumption	400W (450VA) U.S. & Canadian models 600W General (and other) models			
Weight	33 lbs (15 kg)			
Dimensions	Width: 18-7/8 inches (480 mm) Height: 5-1/4 inches (132 mm) Overall Depth: 16-3/4 inches (423 mm) Depth Behind Front Panel: 15-1/8 inches (384 mm)			
Accessory	Rubber cap to discourage unauthorized or accidental changes in setting of input attenuator (included).			

Output Power Specs meet FTC preconditioning criteria	STEREO OPERATION (Power output specified per channel, with both channels driven)				BRIDGED MONO OPERATION			
	8 ohms		4 ohms		16 ohms		8 ohms	
	20Hz – 20kHz	1kHz	20Hz – 20kHz	1kHz	20Hz – 20kHz	1kHz	20Hz – 20kHz	1kHz
Continuous sine wave output power at less than 0.05% THD	100 W	105 W	150 W	165 W	220 W	250 W	300 W	330 W
Total Harmonic Distortion (THD)	≤ 0.007% @ 55 W	≤ 0.003% @ 55 W	≤ 0.01% @ 75 W	≤ 0.005% @ 75 W	≤ 0.007% @ 110 W	≤ 0.003% @ 110 W	≤ 0.01% @ 150 W	≤ 0.005% @ 150 W
Channel Separation (@ 3 dB below nominal power output, ATT @ max, input shorted)	≥ 70 dB	≥ 90 dB						
Intermodulation Distortion (IHD) 60 Hz & 7 kHz 4 : 1	≤ 0.005% @ 55 W		≤ 0.01% @ 75 W		≤ 0.01% @ 110 W		≤ 0.01% @ 150 W	
Power Bandwidth (@ THD ≤ 0.1%)	10 Hz to 50 kHz @ 55 W		10 Hz to 50 kHz @ 75 W		10 Hz to 50 kHz @ 110 W		10 Hz to 50 kHz @ 150 W	
Frequency Response (1 watt output)	+0, -1dB, 10Hz to 50kHz							
Damping Factor	≥ 110 @ 1 kHz				≥ 55 @ 1 kHz			
Slew Rate	± 50 volts/microsecond full swing				± 90 volts/microsecond full swing			
Signal-to-Noise (Input shorted)	≥ 110 dB, -6 dB/octave LPF @ 12.47 kHz ≥ 115 dB, IHF-A network				≥ 106 dB, -6 dB/octave LPF @ 12.47 kHz ≥ 110 dB, IHF-A network			
Residual Noise (Input ATT @ minimum)	≤ -80 dBm, -6 dB/octave LPF @ 12.47 kHz ≤ -90 dBm, IHF-A network							
Input Impedance	≥ 15 kohms, balanced or unbalanced (ATT @ max)							
Sensitivity	+4 dBm (1.23 V rms) for nominal output (4 ohm load)							
Voltage Gain	26.0 dB							
Indicators	Signal: Green LED turns on when signal present at output is at or above 2 volts RMS (20 Hz – 20 kHz) Clipping: Red LED turns on when THD ≥ 1% (x 2). Protection: Red LED turns on when protection or muting is on. Pilot: Red LED turns on when power is on.							
Protection Circuits	Muting: Output muted 6 seconds (± 2 sec.) after power is on. DC sense: Output shut off if ± 2V DC sensed at output. Thermal: Output shut off if heat sink temp. ≥ 85 degrees C. Current Limiter: Output reduced if load ≤ 2 ohms.							
Fan Circuit	Fan is normally at low speed; when heat sink reaches 60 degrees Centigrade, fan goes to high speed; then resets to low at 45°C.							
Controls	Front: 2 x 32 step Input Attenuators; 0 to -20 dB in 1 dB steps, -20 to -30 dB in 2 dB steps, then -33, -37, -42, -50, -60 dB, and infinite attenuation. Push On/Push Off POWER switch. Rear: MONO/STEREO MODE switch.							
Power Requirements	120V AC, 60Hz U.S. & Canadian models 220/240V AC, 50/60Hz: General (and other) models							
Power Consumption	500W (600VA) U.S. & Canadian models 800W General (and other) models							
Weight	37.4 lbs (17 kg)							
Dimensions	Width: 18-7/8 inches (480 mm) Height: 5-1/4 inches (132 mm) Overall Depth: 16-3/4 inches (423 mm) Depth Behind Front Panel: 15-1/8 inches (384 mm)							
Accessories	Rubber caps of discourage unauthorized or accidental changes in setting of input attenuators (included).							

Output Power Specs meet FTC preconditioning criteria	STEREO OPERATION (Power output specified per channel, with both channels driven)				BRIDGED MONO OPERATION			
	8 ohms		4 ohms		16 ohms		8 ohms	
	20Hz – 20kHz	1kHz	20Hz – 20kHz	1kHz	20Hz – 20kHz	1kHz	20Hz – 20kHz	1kHz
Continuous sine wave output power at less than 0.05% THD	170 W	185 W	250 W	265 W	340 W	370 W	500 W	530 W
Total Harmonic Distortion (THD)	≤ 0.007% @ 85 W	≤ 0.003% @ 85 W	≤ 0.01% @ 125 W	≤ 0.005% @ 125 W	≤ 0.007% @ 85 W	≤ 0.003% @ 85 W	≤ 0.01% @ 125 W	≤ 0.005% @ 125 W
Channel Separation (@ 3 dB below nominal power output, ATT @ max, input shorted)	≥ 70 dB	≥ 90 dB						
Intermodulation Distortion (IHD) 60 Hz & 7 kHz 4 : 1	≤ 0.005% @ 85 W		≤ 0.01% @ 125 W		≤ 0.01% @ 170 W		≤ 0.01% @ 250 W	
Power Bandwidth (@ THD ≤ 0.1%)	10 Hz to 50 kHz @ 85 W		10 Hz to 50 kHz @ 125 W		10 Hz to 50 kHz @ 170 W		10 Hz to 50 kHz @ 250 W	
Frequency Response (1 watt output)	+0, -1dB, 10Hz to 50kHz							
Damping Factor	≥ 110 @ 1 kHz				≥ 55 @ 1 kHz			
Slew Rate	± 50 volts/microsecond full swing				± 90 volts/microsecond full swing			
Signal-to-Noise (Input shorted)	≥ 110 dB, -6 dB/octave LPF @ 12.47 kHz ≥ 115 dB, IHF-A network				≥ 106 dB, -6 dB/octave LPF @ 12.47 kHz ≥ 110 dB, IHF-A network			
Residual Noise (Input ATT @ minimum)	≤ -80 dBm, -6 dB/octave LPF @ 12.47 kHz ≤ -90 dBm, IHF-A network							
Input Impedance	≥ 15 kohms, balanced or unbalanced (ATT @ max)							
Sensitivity	+4 dBm (1.23 V rms) for nominal output (4 ohm load)							
Voltage Gain	28.3 dB							
Indicators	Signal: Green LED turns on when signal present at output is at or above 2 volts RMS (20 Hz – 20 kHz). Clipping: Red LED turns on when THD ≥ 1% (x 2). Protection: Red LED turns on when protection or muting is on. Pilot: Red LED turns on when power is on.							
Protection Circuits	Muting: Output muted 6 seconds (± 2 sec.) after power is on. DC sense: Output shut off if ± 2V DC sensed at output. Thermal: Output shut off if heat sink temp. > 85 degrees C. Current Limiter: Output reduced if load ≤ 2 ohms.							
Fan Circuit	Fan is normally at low speed; when heat sink reaches 60 degrees Centigrade, fan goes to high speed; then resets to low at 45°C.							
Controls	Front: 2 x 32 step Input Attenuators; 0 to -20 dB in 1 dB steps, -20 to -30 dB in 2 dB steps, then -33, -37, -42, -50, -60 dB, and infinite attenuation. Push On/ Push Off POWER switch. Rear: MONO/STEREO MODE switch.							
Power Requirements	120V AC, 60Hz U.S. & Canadian models 220/240V AC, 50/60Hz General (and other) models							
Power Consumption	850W (950VA) U.S. & Canadian models 1300W General (and other) models							
Weight	41.8 lbs (19 kg)							
Dimensions	Width: 18-7/8 inches (480 mm) Height: 5-1/4 inches (132 mm) Overall Depth: 16-3/4 inches (423 mm) Depth Behind Front Panel: 15-1/8 inches (384 mm)							
Accessories	Rubber caps to discourage unauthorized or accidental changes in setting of input attenuators (included).							

BLOCK DIAGRAM

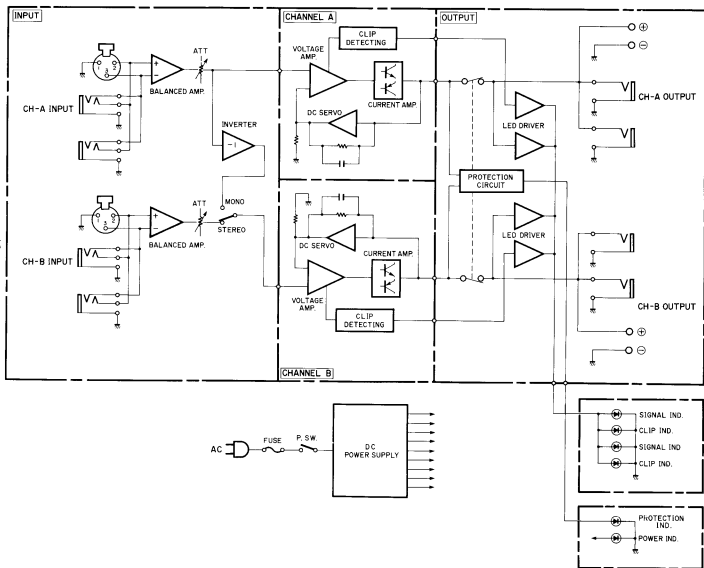

PERFORMANCE GRAPHS

THD vs OUTPUT POWER CHARACTERISTICS

<Model:P2150 >

Load Impedance: 4Ω

Mode: STEREO

Both Channels Driven

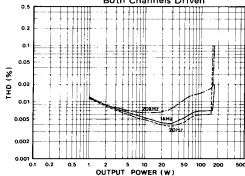

THD vs FREQUENCY CHARACTERISTICS

<Model:P2150 >

Load Impedance: 4Ω

Mode: STEREO

Both Channels Driven

Output Power: 75W constant

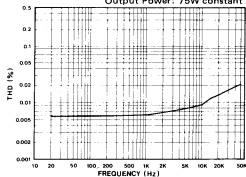

THD vs OUTPUT POWER CHARACTERISTICS

<Model:P2150 >

Load Impedance: 8Ω

Mode: STEREO

Both Channels Driven

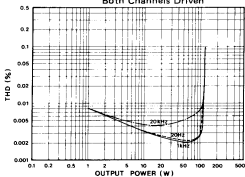

THD vs FREQUENCY CHARACTERISTICS

<Model:P2150 >

Load Impedance: 8Ω

Mode: STEREO

Both Channels Driven

Output Power: 50W constant

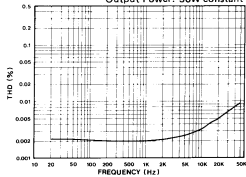

THD vs OUTPUT POWER CHARACTERISTICS

<Model:P2150 >

Load Impedance: 8Ω

Mode: MONO (BTL)

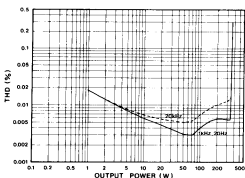

THD vs FREQUENCY CHARACTERISTICS

<Model:P2150 >

Load Impedance: 8Ω

Mode: MONO (BTL)

Output Power: 150W constant

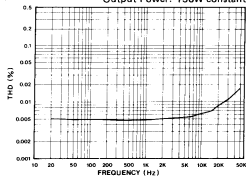

THD vs OUTPUT POWER CHARACTERISTICS

<Model:P2250>

Load Impedance: 4Ω
Mode: STEREO
Both Channels Driven

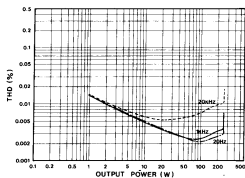

THD vs FREQUENCY CHARACTERISTICS

<Model:P2250>

Load Impedance: 4Ω
Mode: STEREO
Both Channels Driven
Output Power: 125W constant

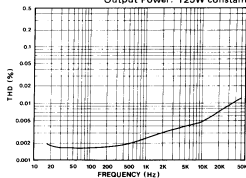

THD vs OUTPUT POWER CHARACTERISTICS

<Model:P2250>

Load Impedance: 8Ω
Mode: STEREO
Both Channels Driven

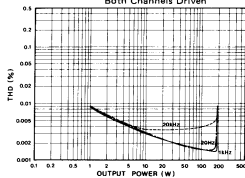

THD vs FREQUENCY CHARACTERISTICS

<Model:P2250>

Load Impedance: 8Ω
Mode: STEREO
Both Channels Driven
Output Power: 85W constant

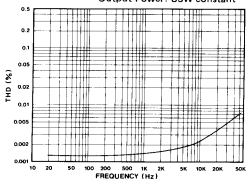

THD vs OUTPUT POWER CHARACTERISTICS

<Model:P2250>

Load Impedance: 8Ω
Mode: MONO (BTL)

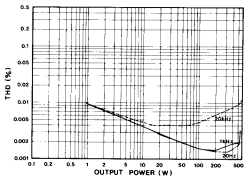

THD vs FREQUENCY CHARACTERISTICS

<Model:P2250>

Load Impedance: 8Ω
Mode: MONO (BTL)
Output Power: 250W

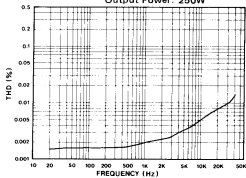

DAMPING FACTOR CHARACTERISTICS

<Model:P2250>

Load Impedance: 8Ω

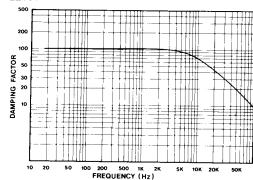

FREQUENCY RESPONSE CHARACTERISTICS

<Model:all models>

Load Impedance: 8Ω
Input Attenuators: Max

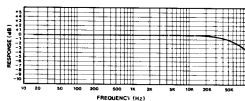

DIMENSIONS

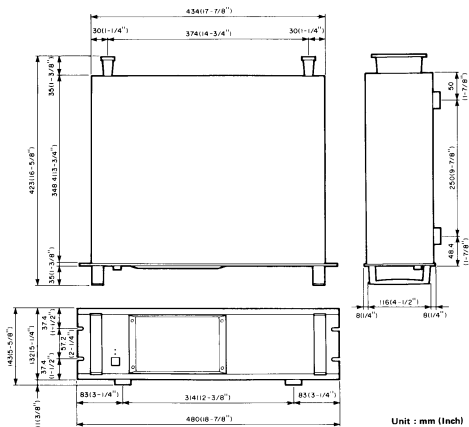

SERVICE

The P1150/P1250/P2150/P2250 are supported by Yamaha's worldwide network of factory trained and qualified dealer service personnel. In the event of a problem, contact your nearest Yamaha dealer.

SINCE 1947  **YAMAHA**
NIPPON GAKKI CO., LTD. HAMAMATSU, JAPAN